

*The eGaN[®] Technology
Journey Continues*

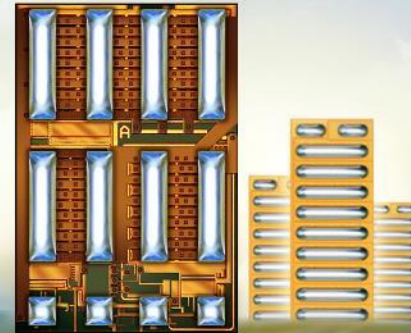

EPC2204 Thermal Model

EPC2204 FEA thermal simulations



- The thermal model applies to EPC2204.
- A power dissipation of 1 W in the device active area is assumed.
- Finite element analysis (FEA) thermal simulations
 - $R_{\Theta JB}$ and $R_{\Theta JC}$ are obtained by stationary simulations.
 - $Z_{\Theta JB}$ and $Z_{\Theta JC}$ are obtained by transient simulations.
- R-C thermal model is generated.

EPC2204 geometry in simulation

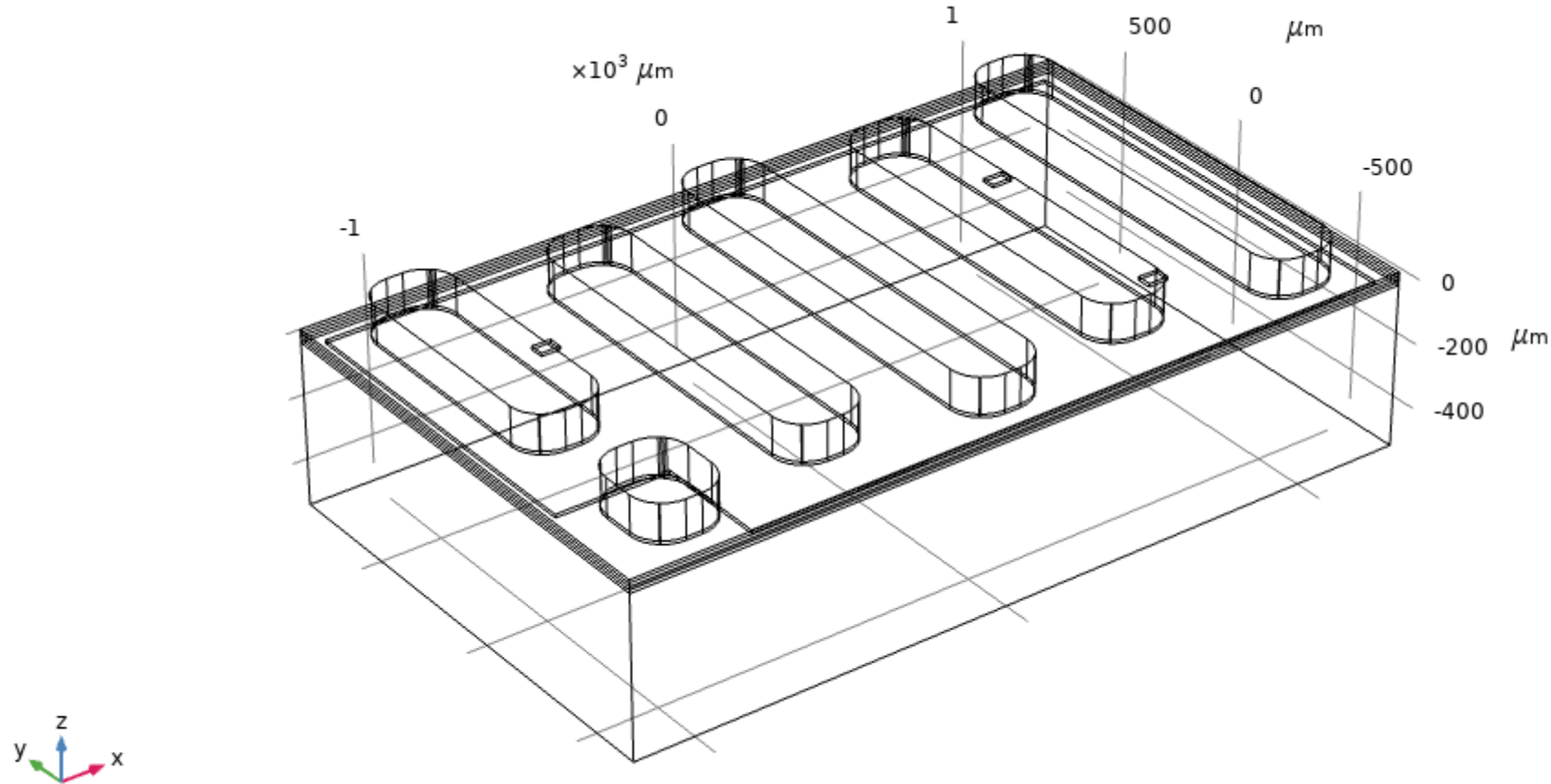

EPC2204 Steady-state $R_{\Theta JB}$

Typical $R_{\Theta JB} = 2.5 \text{ }^{\circ}\text{C/W}$

Volume: Temperature (K)

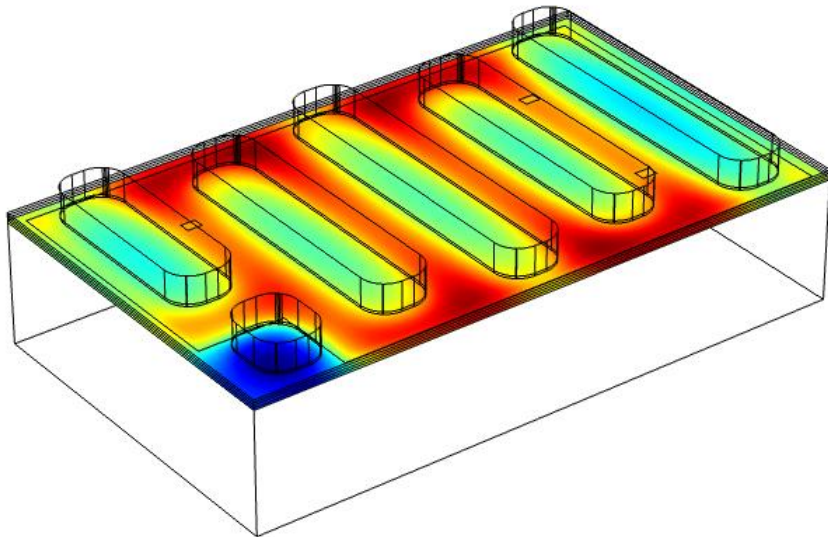

Volume: Temperature (K)

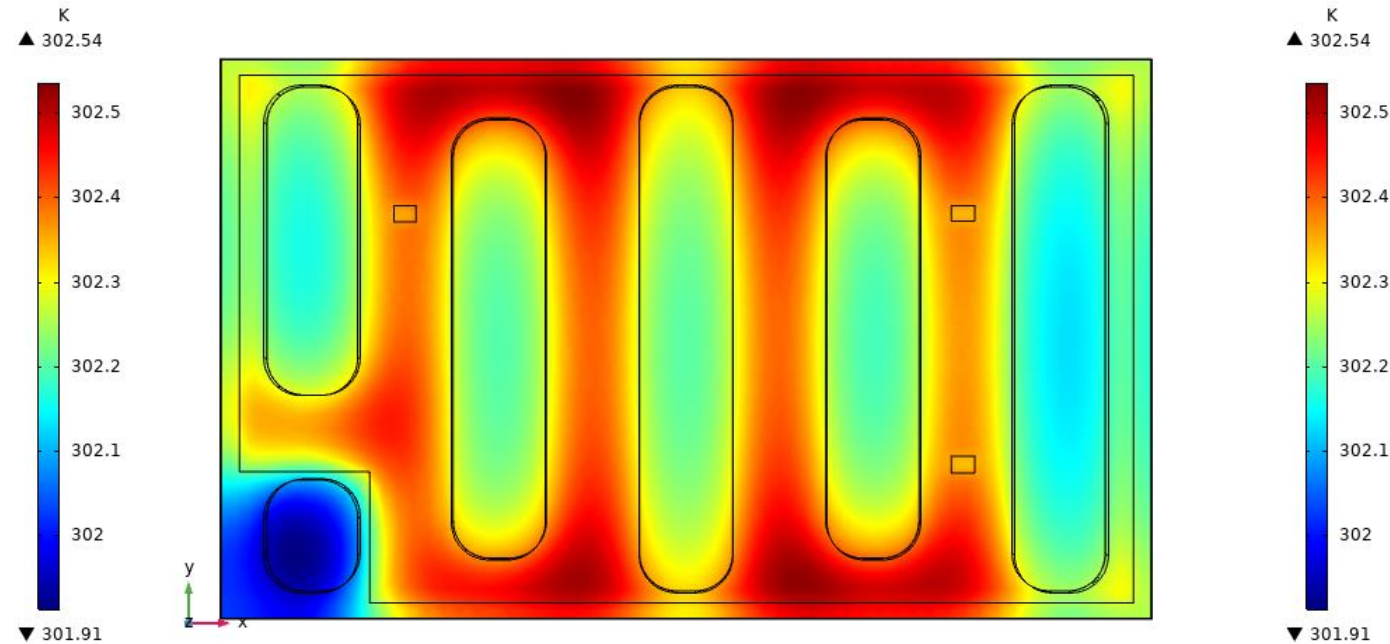

- Operating condition: Power = 1 W in the active area.
- Boundary condition: Temperature of top of solder bumps set to be 300 K.

EPC2204 Steady-state $R_{\theta JC}$

Typical $R_{\theta JC} = 1 \text{ }^\circ\text{C/W}$

Volume: Temperature (K)

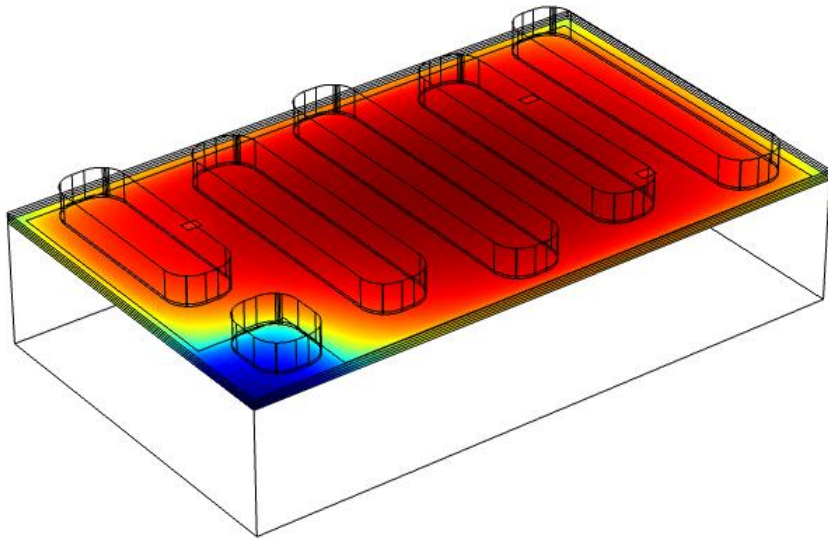

Volume: Temperature (K)

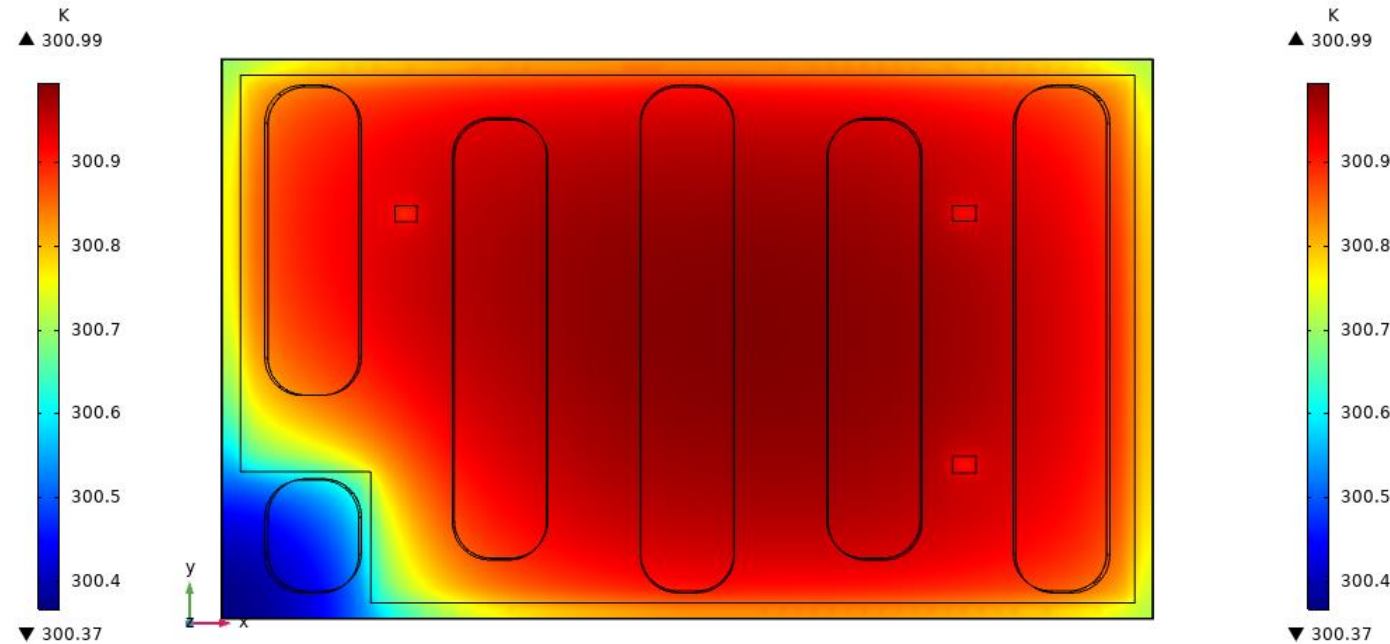

- Operating condition: Power = 1 W in the active area.
- Boundary condition: Temperature of the device backside set to be 300 K.

EPC2204 $Z_{\Theta JB}$ R-C thermal model

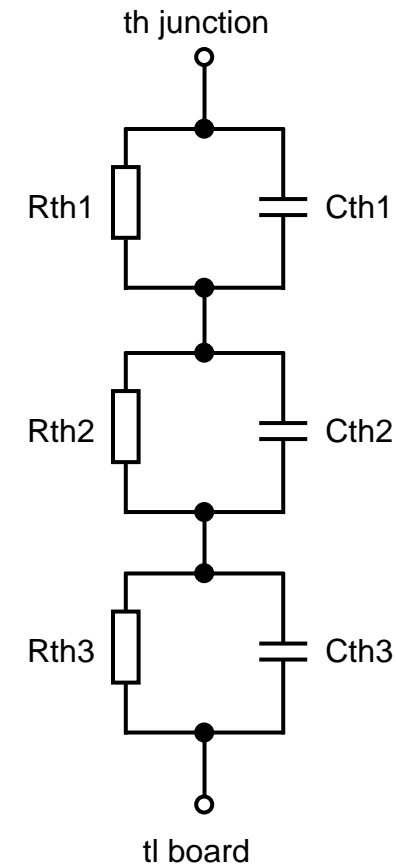
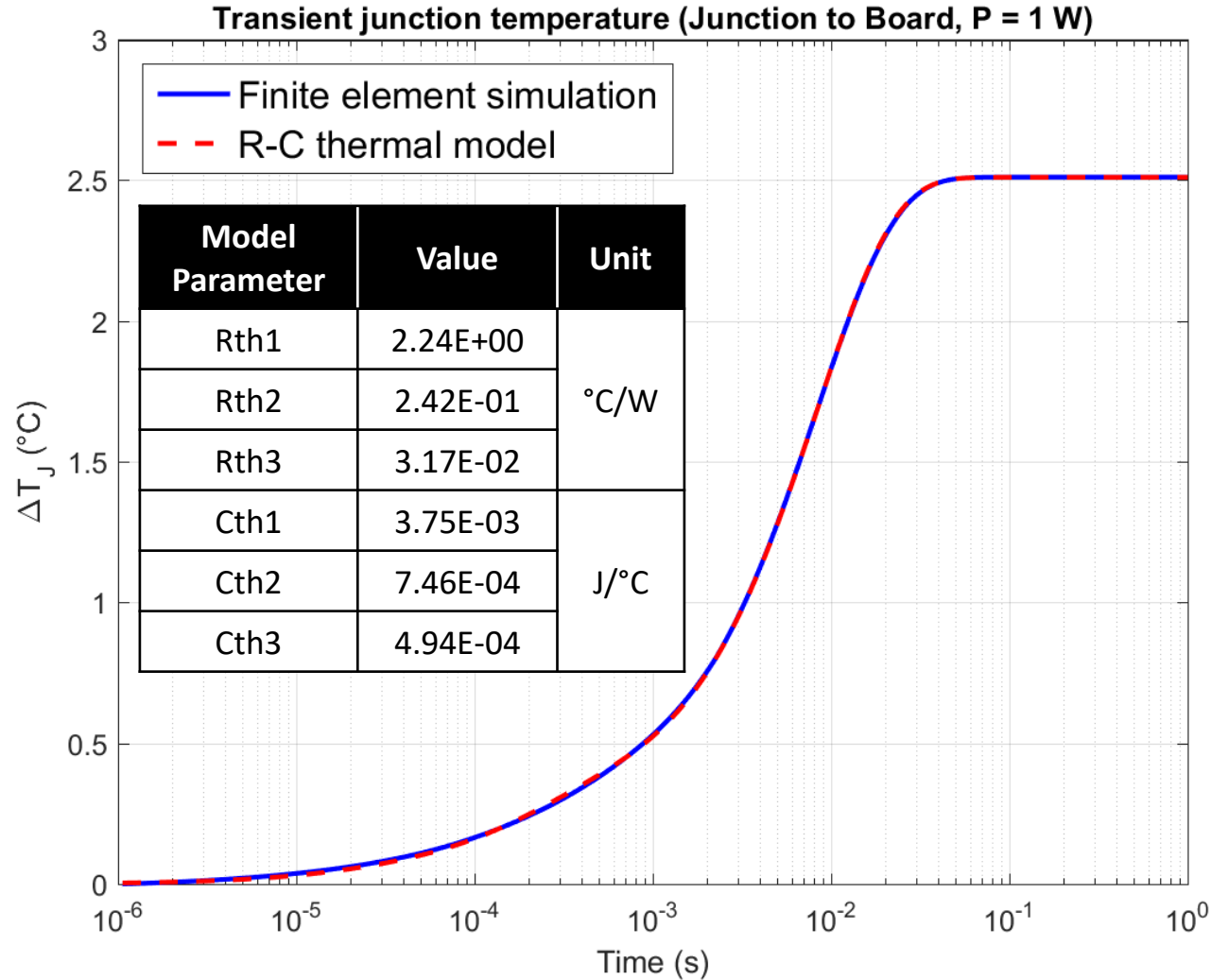

EPC2204 $Z_{\Theta JC}$ R-C thermal model

