

Main Supply Input

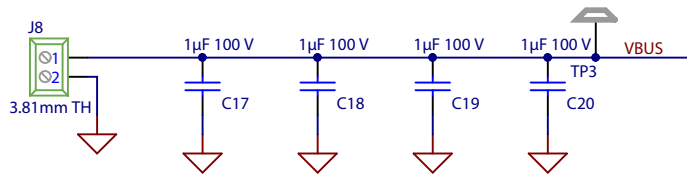

Logic Supply

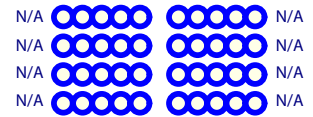
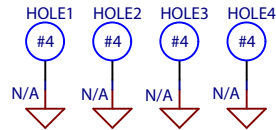
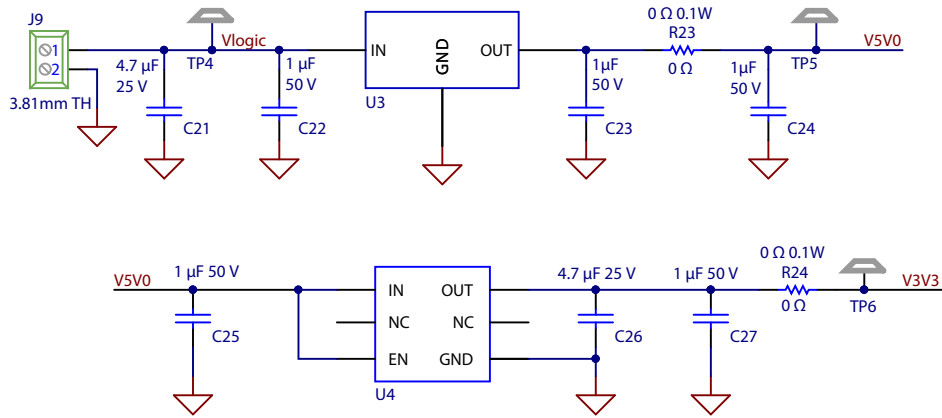

Figure 6: Schematic EPC9156 (part1)

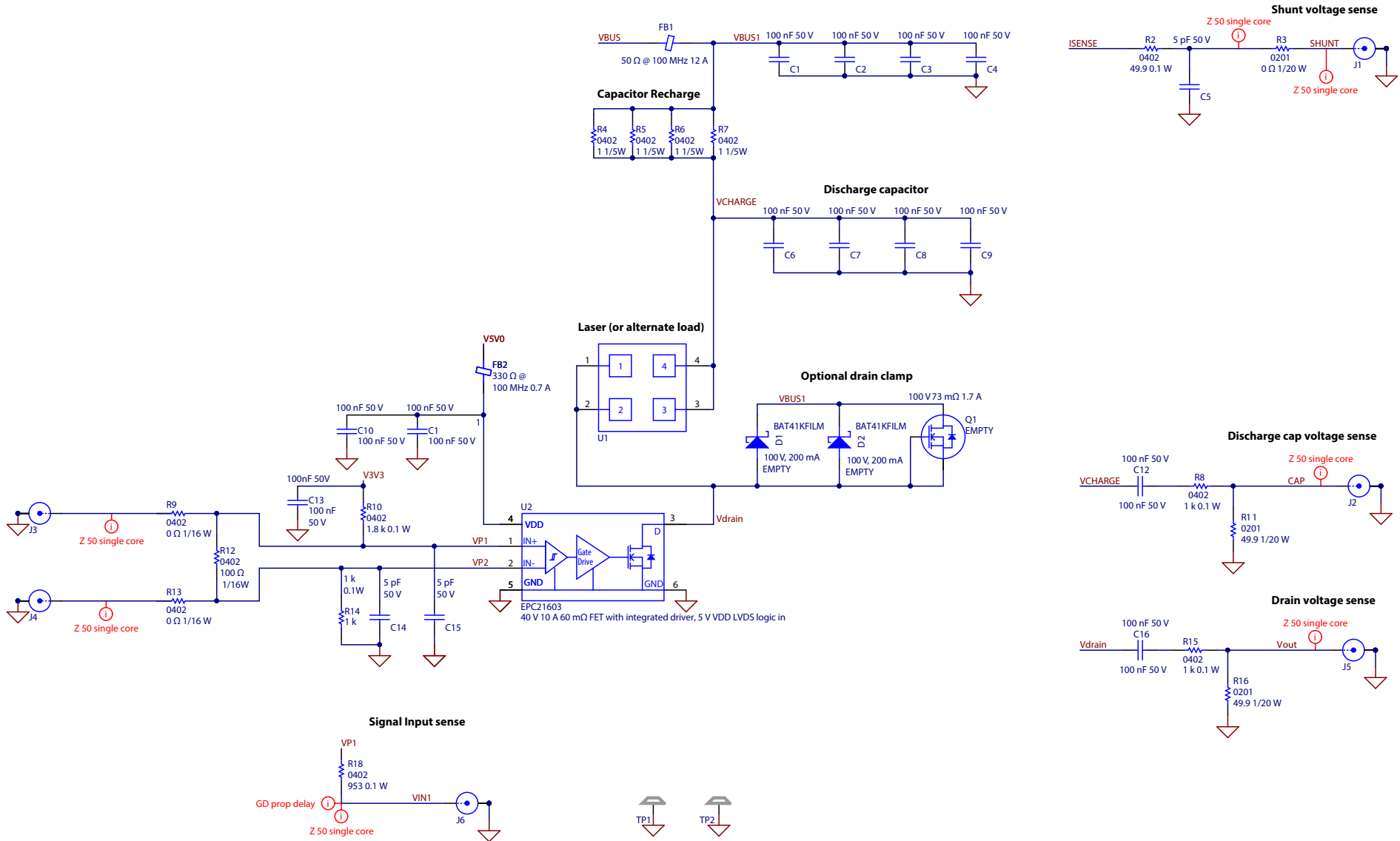

Figure 7: Schematic EPC9156 (part 2)