

# EPC1007 – Enhancement Mode Power Transistor

$$V_{DSS}, 100\text{ V}$$

$$R_{DS(ON)}, 30\text{ m}\Omega$$

$$I_D, 6\text{ A}$$

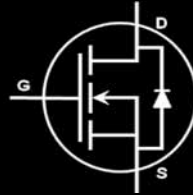

Gallium Nitride is grown on Silicon Wafers and processed using standard CMOS equipment leveraging the infrastructure that has been developed over the last 55 years. GaN's exceptionally high electron mobility and low temperature coefficient allows very low  $R_{DS(ON)}$ , while its lateral device structure and majority carrier diode provide exceptionally low  $Q_G$  and zero  $Q_{RR}$ . The end result is a device that can handle tasks where very high switching frequency, and low on-time are beneficial as well as those where on-state losses dominate.



EPC Power Transistors are supplied only in passivated die form with solder bumps

### Applications

- High Speed DC-DC conversion
- Class D Audio
- Hard Switched and High Frequency Circuits

### Benefits

- Ultra High Efficiency
- Ultra Low  $R_{DS(on)}$
- Ultra low  $Q_G$
- Ultra small footprint

Maximum Ratings			
$V_{DS}$	Drain-to-Source Voltage	100	V
$I_D$	Continuous ( $T_A = 25^\circ\text{C}$ , $\theta_{JA} = 90$ )	6	A
	Pulsed ( $25^\circ\text{C}$ , $T_{\text{pulse}} = 300\ \mu\text{s}$ )	25	
$V_{GS}$	Gate-to-Source Voltage	6	V
	Gate-to-Source Voltage	-5	
$T_J$	Operating Temperature	-40 to 125	$^\circ\text{C}$
$T_{STG}$	Storage Temperature	-40 to 150	

PARAMETER	TEST CONDITIONS	MIN	TYP	MAX	UNIT
<b>Static Characteristics</b> ( $T_J = 25^\circ\text{C}$ unless otherwise stated)					
$BV_{DSS}$	Drain-to-Source Voltage	$V_{GS} = 0\text{ V}, I_D = 75\ \mu\text{A}$	100		V
$I_{DSS}$	Drain Source Leakage	$V_{DS} = 80\text{ V}, V_{GS} = 0\text{ V}$	20	60	$\mu\text{A}$
$I_{GSS}$	Gate-Source Forward Leakage	$V_{GS} = 5\text{ V}$	.25	2	mA
	Gate-Source Reverse Leakage	$V_{GS} = -5\text{ V}$	0.1	0.5	
$V_{GS(th)}$	Gate Threshold Voltage	$V_{DS} = V_{GS}, I_D = 1.2\text{ mA}$	0.7	1.4	V
$R_{DS(ON)}$	Drain-Source On Resistance	$V_{GS} = 5\text{ V}, I_D = 6\text{ A}$	24	30	$\text{m}\Omega$
<b>Dynamic Characteristics</b> ( $T_J = 25^\circ\text{C}$ unless otherwise stated)					
$C_{ISS}$	Input Capacitance	$V_{DS} = 50\text{ V}, V_{GS} = 0\text{ V}$	200		pF
$C_{OSS}$	Output Capacitance		110		
$C_{RSS}$	Reverse Transfer Capacitance		10		
$Q_G$	Total Gate Charge ( $V_{GS} = 5\text{ V}$ )	$V_{DS} = 50\text{ V}, I_D = 6\text{ A}$	2.7		nC
$Q_{GD}$	Gate-to-drain Charge		1		
$Q_{GS}$	Gate-to Source Charge		0.75		
$Q_{OSS}$	Output Charge		8		
$Q_{RR}$	Source-Drain Recovery Charge		0		
<b>Source-Drain Characteristics</b> ( $T_J = 25^\circ\text{C}$ unless otherwise stated)					
$V_{SD}$	Source-Drain Forward Voltage	$I_S = 0.5\text{ A}, V_{GS} = 0\text{ V}, T = 25^\circ\text{C}$	1.8		V
		$I_S = 0.5\text{ A}, V_{GS} = 0\text{ V}, T = 125^\circ\text{C}$	1.75		

Figure 1: Typical Output Characteristics

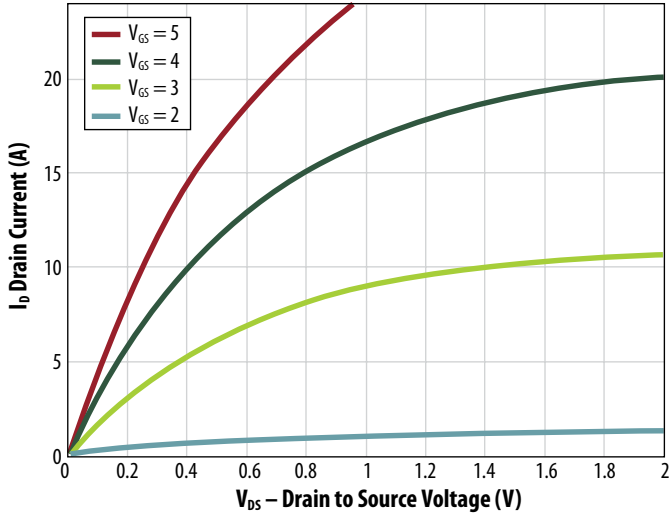

Figure 2: Transfer Characteristics

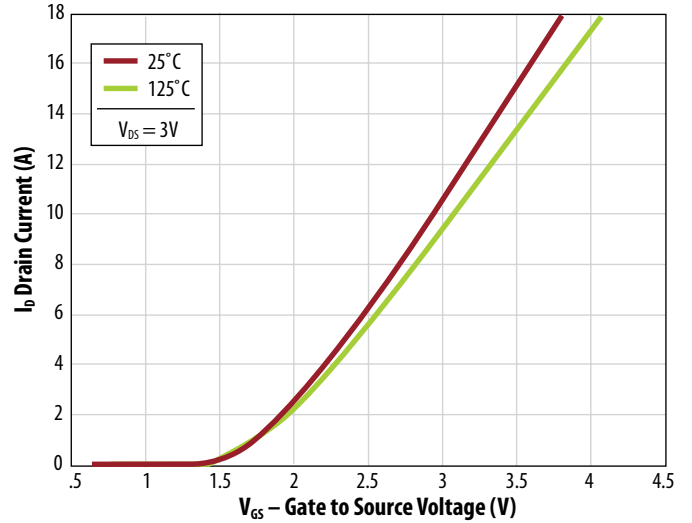

Figure 3:  $R_{DS(ON)}$  vs  $V_G$  for Various Current

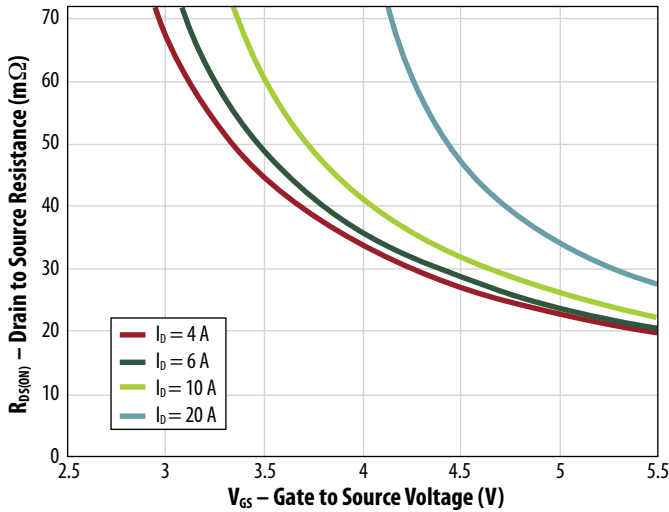

Figure 4:  $R_{DS(ON)}$  vs  $V_G$  for Various Temperature

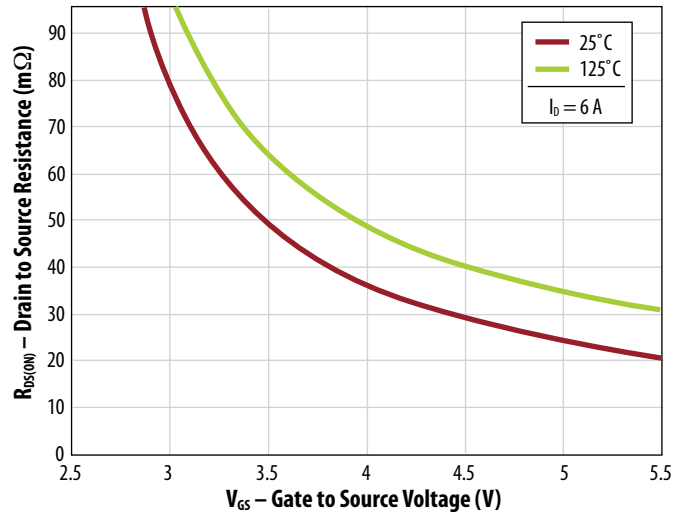

Figure 5: Capacitance

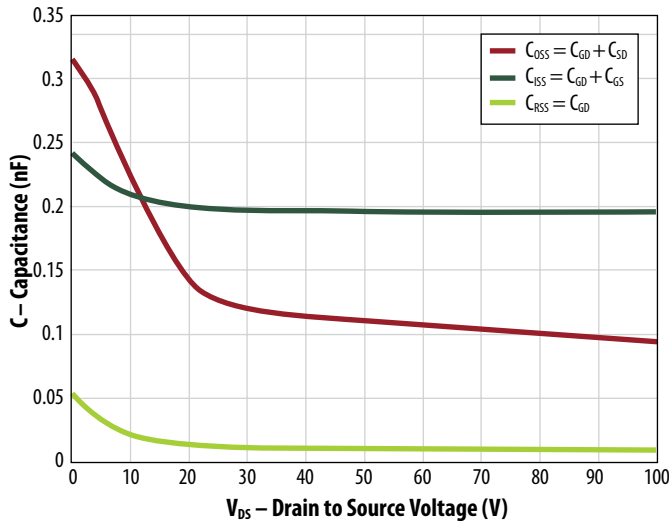

Figure 6: Gate Charge

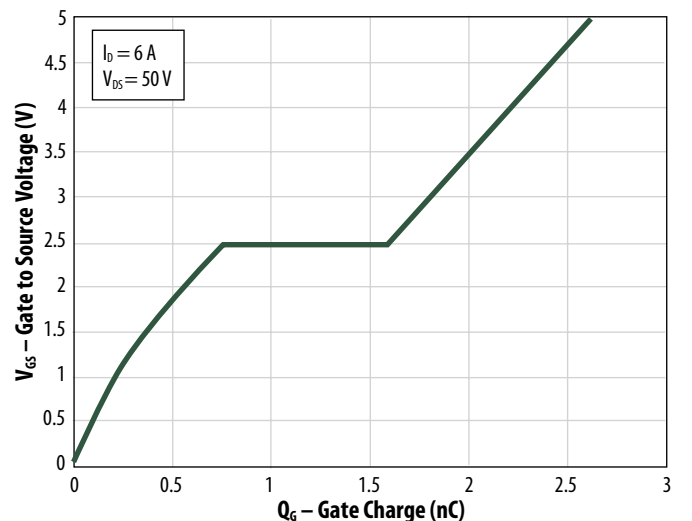

Figure 7: Reverse Drain-Source Characteristics

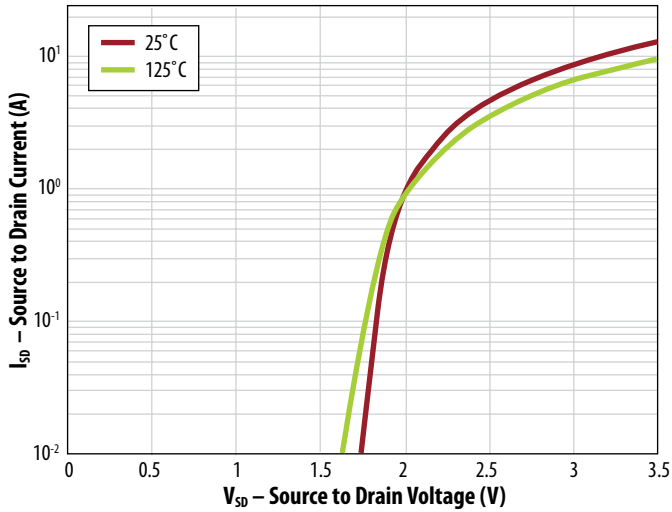

Figure 8: Normalized On Resistance Vs Temperature

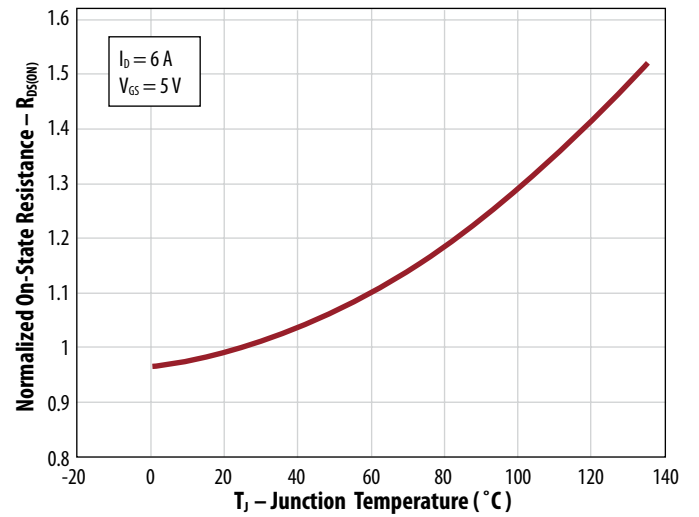

Figure 9: Normalized Threshold Voltage

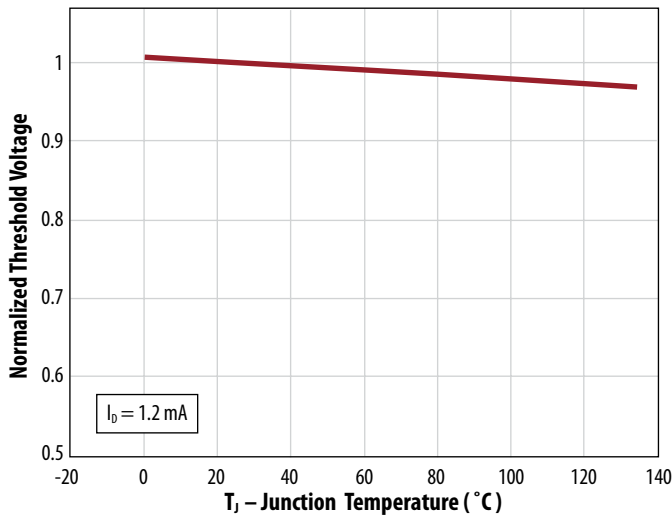
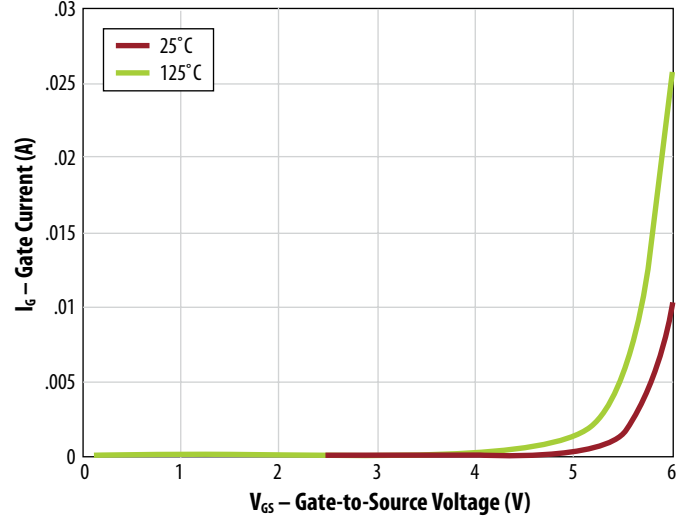
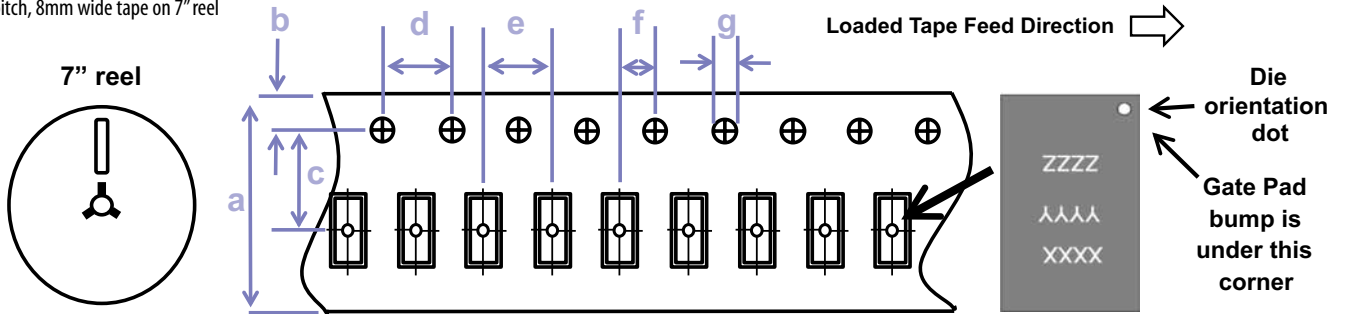

Figure 10: Gate Current



TAPE AND REEL CONFIGURATION

4mm pitch, 8mm wide tape on 7" reel



EPC1007			
Dimension (mm)	target	min	max
a	8.00	7.90	8.30
b	1.75	1.65	1.85
c (see note)	3.50	3.45	3.55
d	4.00	3.90	4.10
e	4.00	3.90	4.10
f (see note)	2.00	1.95	2.05
g	1.5	1.5	1.6

Note: Pocket position is relative to the sprocket hole measured as true position of the pocket, not the pocket hole

DIE MARKINGS

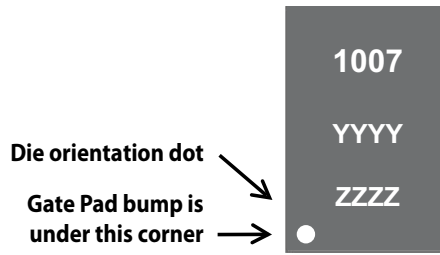

Part Number	Laser Markings		
	Part # Marking Line 1	Lot_Date Code Marking line 2	Lot_Date Code Marking Line 3
EPC1007	1007	YYYY	ZZZZ

DIE OUTLINE

Bottom View

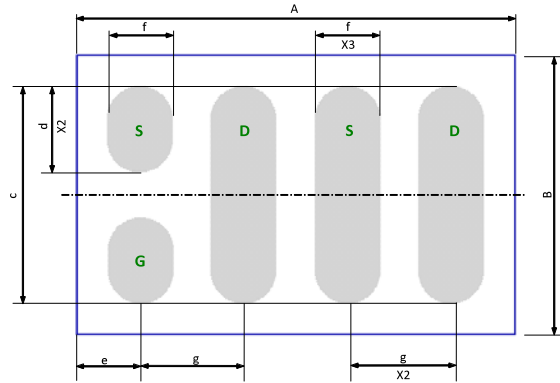

DIM	MICROMETERS		
	MIN	Nominal	MAX
A	1672	1702	1732
B	1057	1087	1117
c	834	837	840
d	327	330	333
e	235	250	265
f	248	250	252
g	400	400	400

Side View

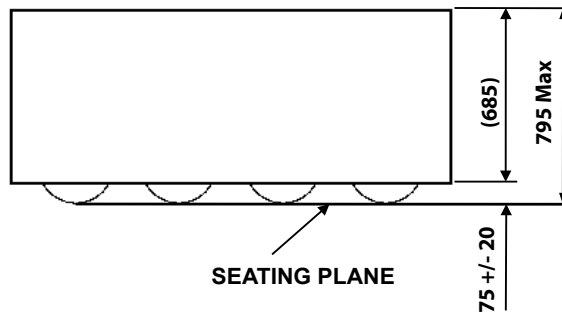

RECOMMENDED LAND PATTERN

(measurements in  $\mu\text{m}$ )

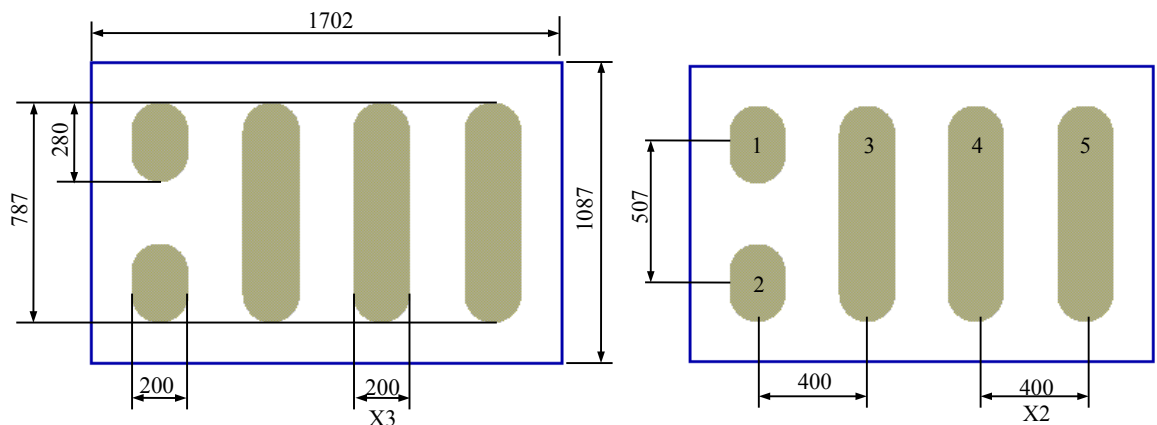

Pad no. 1 is Gate;  
Pads no. 3 and 5 are Drain;  
Pads no. 2 and 4 are Source.