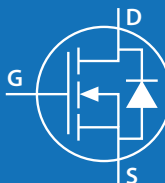


# EPC2305 – Enhancement Mode Power Transistor

$V_{DS}$ , 150 V

$R_{DS(on)}$ , 2.2 mΩ typ



RoHS

Halogen-Free

Revised March 25, 2025

## General Description

The EPC2305 is a 150 V eGaN® power transistor in a low inductance 3 x 5 mm QFN package with exposed top for excellent thermal management.

The thermal resistance to case top is ~0.2 °C/W, resulting in excellent thermal behavior and easy cooling. The device features an enhanced PQFN “Thermal-Max” package. The exposed top enhances top-side thermal management and the side-wettable flanks guarantee that the complete side-pad surface is wetted with solder during the reflow soldering process, which protects the copper and allows soldering to occur on this external flank area for easy optical inspection.

Compared to a Si MOSFET, the footprint of 15 mm<sup>2</sup> is less than half of the size of the best-in-class Si MOSFET with similar  $R_{DS(on)}$  and voltage rating,  $Q_G$  and  $Q_{GD}$  are significantly smaller and  $Q_{RR}$  is 0. This results in lower switching losses and lower gate driver losses. In summary, EPC2305 allows the highest power density due to enhanced efficiency, smaller size, and higher switching frequency for smaller inductor and fewer capacitors.

The EPC2305 enables designers to improve efficiency and save space. The excellent thermal behavior enables easier and lower cost cooling. The ultra-low capacitance and zero reverse recovery of the eGaN® FET enables efficient operation in many topologies. Performance is further enhanced due to the small, low inductance footprint.

## Application Notes:

- Easy-to-use and reliable gate, Gate Drive ON = 5 V typical, OFF = 0 V (negative voltage not needed)
- Top of FET is electrically connected to source

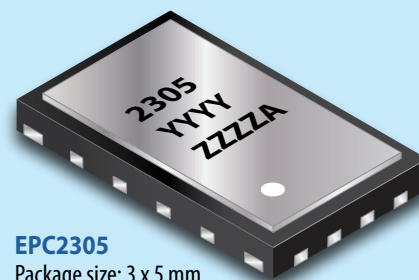


Maximum Ratings			
PARAMETER		VALUE	UNIT
$V_{DS}$	Drain-to-Source Voltage (Continuous)	150	V
$V_{DS(tr)}$	Drain-to-Source Voltage (Repetitive Transient) <sup>(1)</sup>	170	
$I_D$	Continuous ( $T_J \leq 125^\circ\text{C}$ ) <sup>(2)</sup>	102	A
	Pulsed ( $25^\circ\text{C}$ , $T_{PULSE} = 300 \mu\text{s}$ )	329	
$V_{GS}$	Gate-to-Source Voltage	6	V
	Gate-to-Source Voltage	-4	
$T_J$	Operating Temperature	-40 to 150	°C
$T_{STG}$	Storage Temperature	-55 to 175	

<sup>(1)</sup> Pulsed repetitively, duty cycle factor ( $DC_{Factor}$ )  $\leq 1\%$ ;

See Figure 13 and [Reliability Report Phase 16](#), Section 3.2.6

<sup>(2)</sup> Electromigration current limit; See [Reliability Report Phase 16](#), Section 3.3.4



**EPC2305**

Package size: 3 x 5 mm

## Features

- 150 V
- 2.2 mΩ typical
- 3 x 5 mm QFN package
- Moisture rating MSL2

## Applications

- High frequency DC/DC
- AC/DC chargers and adaptors
- BLDC motor drive
- eMobility motor drives
- Solar optimizer & MPPT
- Synchronous rectification for chargers, adaptors, power supplies
- Class-D audio
- Fast charging for phone & notebook, gaming PC
- DC/DC and chargers for eMobility, power tools, vacuum cleaners

## Benefits

- Ultra high efficiency
- No reverse recovery
- Ultra low  $Q_G$
- Small footprint
- Excellent thermal

Scan QR code or click link below for more information including reliability reports, device models, demo boards!



<https://l.ead.me/EPC2305>

## Thermal Characteristics

PARAMETER		TYP	UNIT
$R_{\theta JC}$	Thermal Resistance, Junction-to-Case (Case TOP)	0.2	°C/W
$R_{\theta JB}$	Thermal Resistance, Junction-to-Board (Case BOTTOM)	1.5	
$R_{\theta JA\_JEDEC}$	Thermal Resistance, Junction-to-Ambient (using JEDEC 51-2 PCB)	45	
$R_{\theta JA\_EVB}$	Thermal Resistance, Junction-to-Ambient (using EPC90142 EVB)	21	

Static Characteristics ( $T_J = 25^\circ\text{C}$  unless otherwise stated)

PARAMETER		TEST CONDITIONS	MIN	TYP	MAX	UNIT
$BV_{DSS}$	Drain-to-Source Voltage	$V_{GS} = 0\text{ V}, I_D = 0.2\text{ mA}$	150			V
$I_{DSS}$	Drain-Source Leakage	$V_{DS} = 120\text{ V}, V_{GS} = 0\text{ V}$		0.04	0.2	mA
$I_{GSS}$	Gate-to-Source Forward Leakage	$V_{GS} = 5\text{ V}$		0.02	2	
	Gate-to-Source Forward Leakage <sup>#</sup>	$V_{GS} = 5\text{ V}, T_J = 125^\circ\text{C}$		0.8	7	
	Gate-to-Source Reverse Leakage	$V_{GS} = -4\text{ V}$		0.1	4	
$V_{GS(TH)}$	Gate Threshold Voltage	$V_{DS} = V_{GS}, I_D = 11\text{ mA}$	0.8	1.1	2.5	V
$R_{DS(on)}$	Drain-Source On Resistance	$V_{GS} = 5\text{ V}, I_D = 30\text{ A}$		2.2	3.0	mΩ
$V_{SD}$	Source-to-Drain Forward Voltage <sup>#</sup>	$I_S = 0.5\text{ A}, V_{GS} = 0\text{ V}$		1.4		V

# Defined by design. Not subject to production test.

Dynamic Characteristics<sup>#</sup> ( $T_J = 25^\circ\text{C}$  unless otherwise stated)

PARAMETER		TEST CONDITIONS	MIN	TYP	MAX	UNIT
$C_{ISS}$	Input Capacitance	$V_{DS} = 75\text{ V}, V_{GS} = 0\text{ V}$		3060	4165	pF
$C_{RSS}$	Reverse Transfer Capacitance			5		
$C_{OSS}$	Output Capacitance			852	1063	
$C_{OSS(ER)}$	Effective Output Capacitance, Energy Related (Note 1)	$V_{DS} = 0\text{ to }75\text{ V}, V_{GS} = 0\text{ V}$		1053		
$C_{OSS(TR)}$	Effective Output Capacitance, Time Related (Note 2)			1371		
$R_G$	Gate Resistance			0.5		Ω
$Q_G$	Total Gate Charge	$V_{DS} = 75\text{ V}, V_{GS} = 5\text{ V}, I_D = 30\text{ A}$		22	28.6	nC
$Q_{GS}$	Gate-to-Source Charge	$V_{DS} = 75\text{ V}, I_D = 30\text{ A}$		6.6		
$Q_{GD}$	Gate-to-Drain Charge			2.1		
$Q_{G(TH)}$	Gate Charge at Threshold			4.6		
$Q_{OSS}$	Output Charge		$V_{DS} = 75\text{ V}, V_{GS} = 0\text{ V}$		103	
$Q_{RR}$	Source-Drain Recovery Charge			0		

# Defined by design. Not subject to production test.

All measurements were done with substrate shorted to source.

Note 1:  $C_{OSS(ER)}$  is a fixed capacitance that gives the same stored energy as  $C_{OSS}$  while  $V_{DS}$  is rising from 0 to 50%  $BV_{DSS}$ .

Note 2:  $C_{OSS(TR)}$  is a fixed capacitance that gives the same charging time as  $C_{OSS}$  while  $V_{DS}$  is rising from 0 to 50%  $BV_{DSS}$ .

Figure 1: Typical Output Characteristics at 25°C

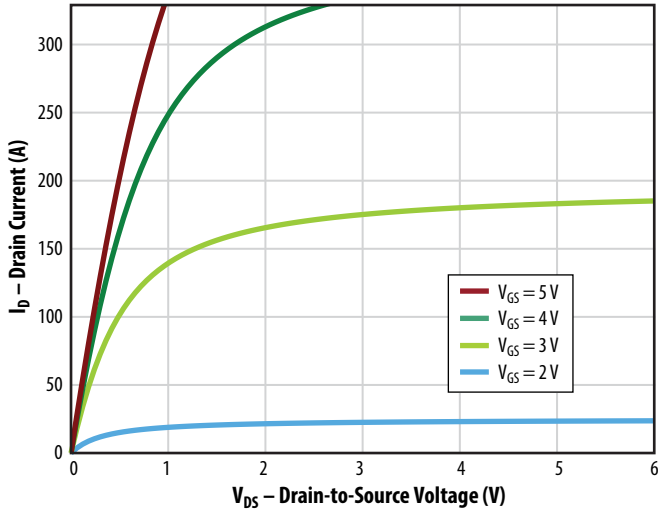


Figure 2: Typical Transfer Characteristics

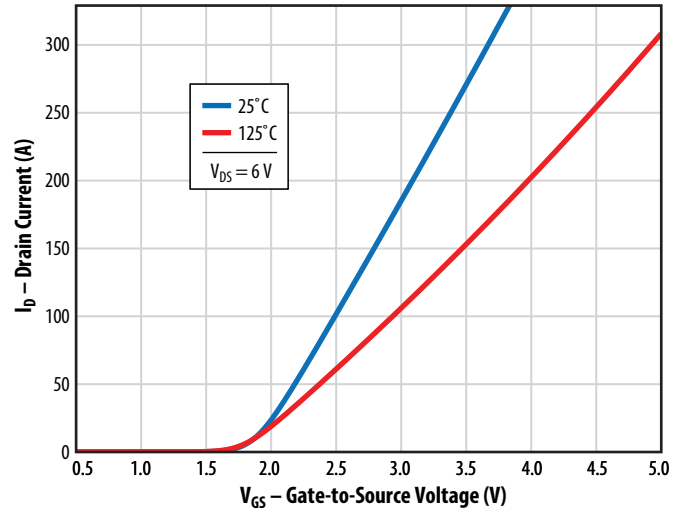


Figure 3: Typical  $R_{DS(on)}$  vs.  $V_{GS}$  for Various Drain Currents

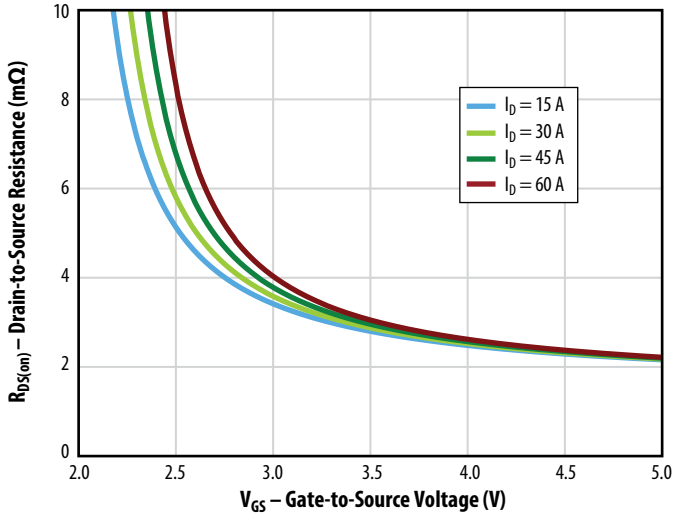


Figure 4: Typical  $R_{DS(on)}$  vs.  $V_{GS}$  for Various Temperatures

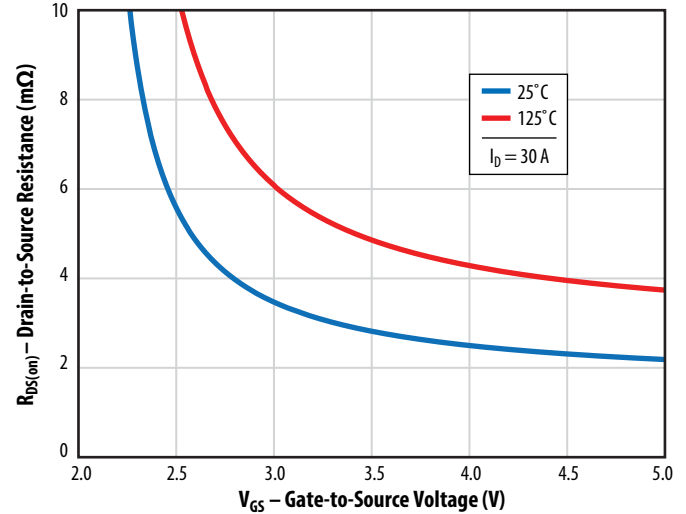


Figure 5a: Typical Capacitance (Linear Scale)

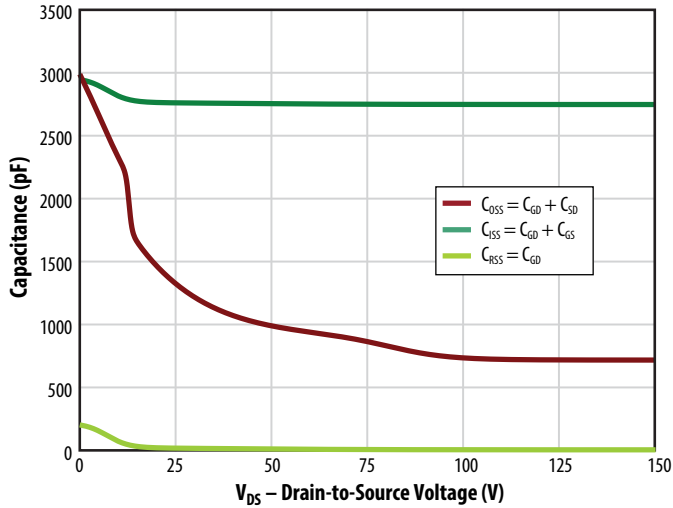
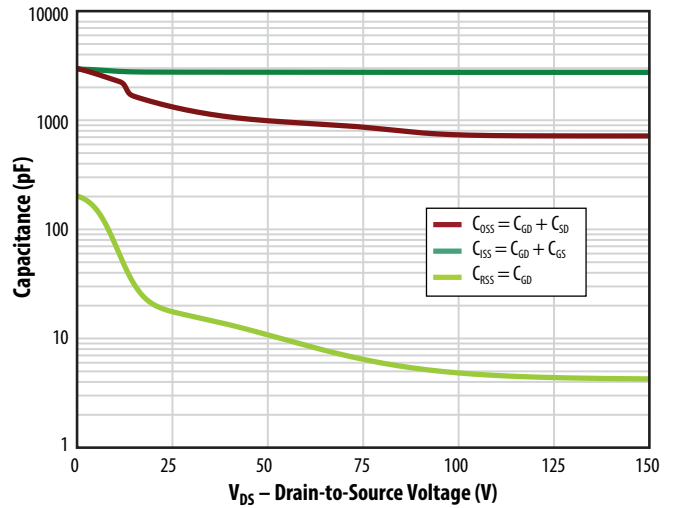
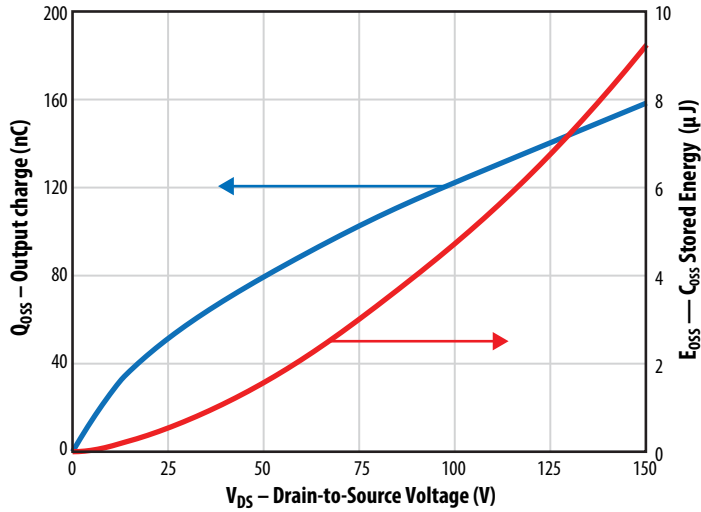


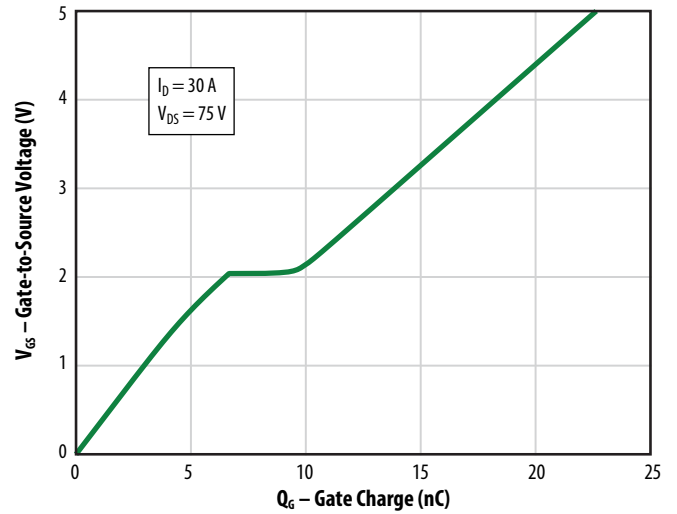
Figure 5b: Typical Capacitance (Log Scale)



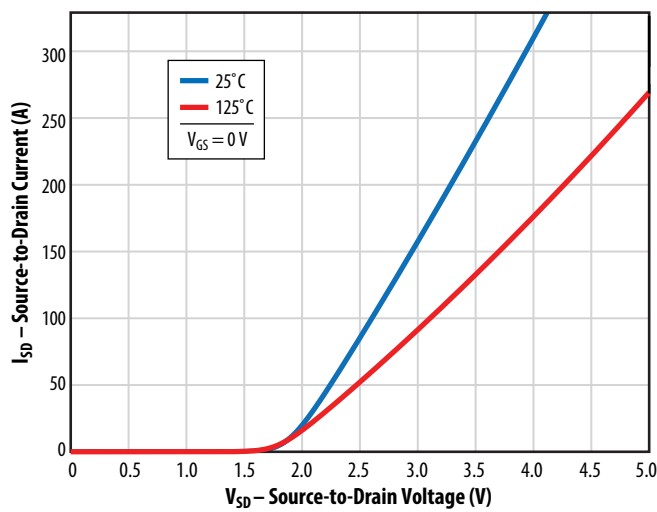
**Figure 6: Typical Output Charge and  $C_{OSS}$  Stored Energy**



**Figure 7: Typical Gate Charge**

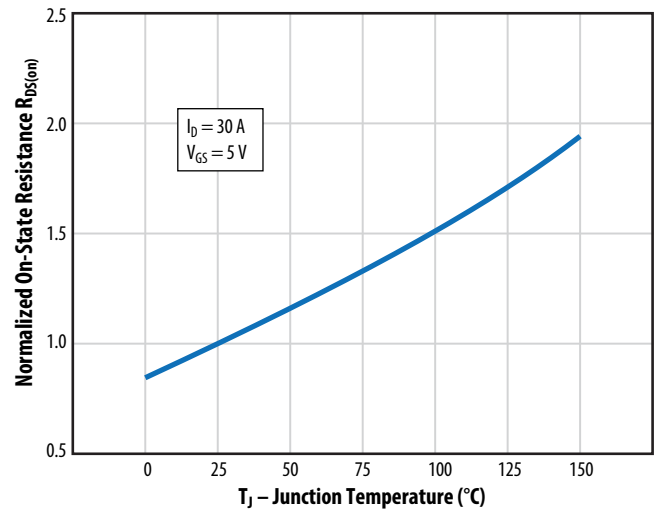


**Figure 8: Typical Reverse Drain-Source Characteristics**

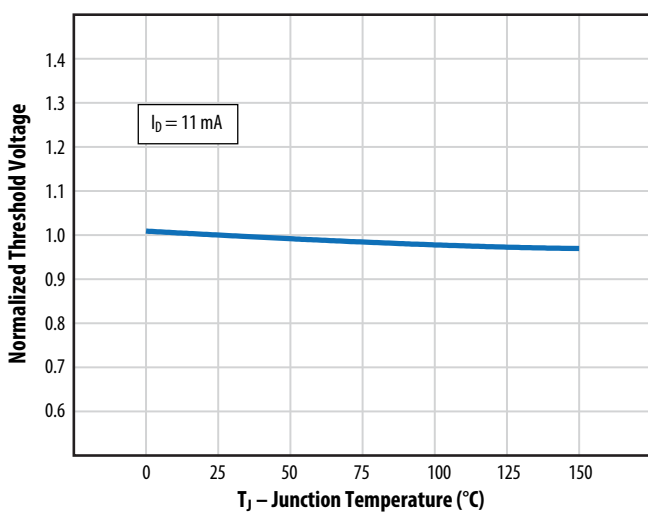


Negative gate drive voltage increases the reverse drain-source voltage.  
EPC recommends 0V for OFF

**Figure 9: Typical Normalized On-State Resistance vs. Temp.**



**Figure 10: Typical Normalized Threshold Voltage vs. Temp.**



**Figure 11: Safe Operating Area**

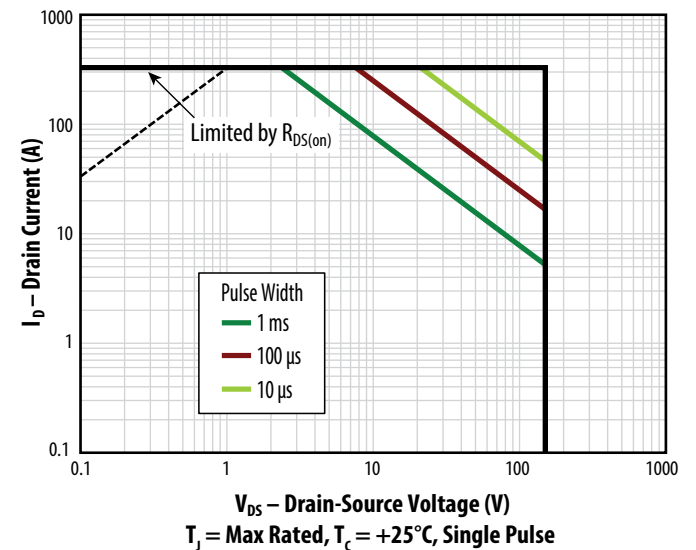


Figure 12: Typical Transient Thermal Response Curves

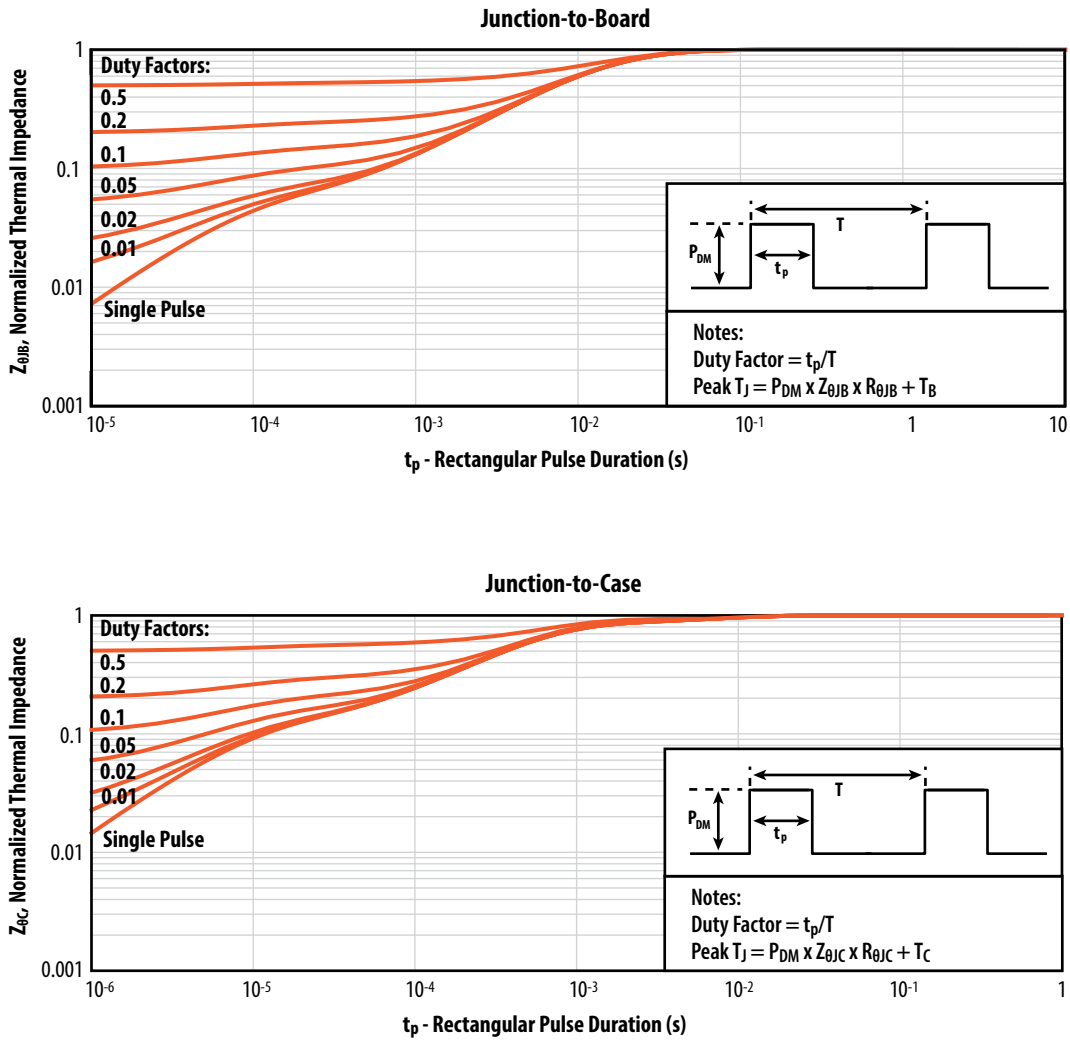
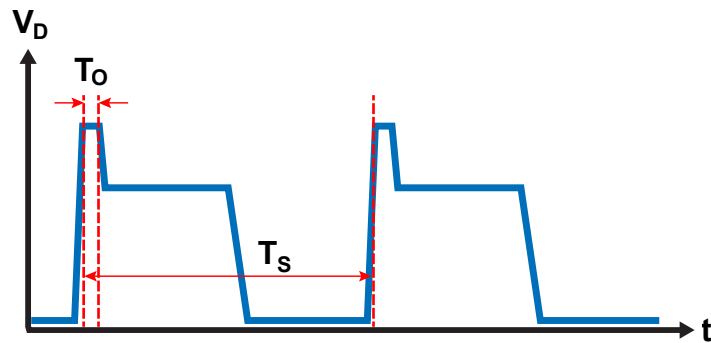


Figure 13: Duty Cycle Factor ( $DC_{Factor}$ ) Illustration for Repetitive Overvoltage Specification



1% is the ratio between  $T_0$  (overvoltage duration) and  $T_s$  (one switching period).

## LAYOUT CONSIDERATIONS

GaN transistors generally behave like power MOSFETs, but at much higher switching speeds and power densities, therefore layout considerations are very important, and care must be taken to minimize layout parasitic inductances. The recommended design utilizes the first inner layer as a power loop return path. This return path is located directly beneath the top layer's power loop allowing for the smallest physical loop size. This method is also commonly referred to as flux cancellation. Variations of this concept can be implemented by placing the bus capacitors either next to the high side device, next to the low side device, or between the low and high side devices, but in all cases the loop is closed using the first inner layer right beneath the devices.

A similar concept is also used for the gate loop, with the return gate loop located directly under the turn ON and OFF gate resistors.

Furthermore, to minimize the common source inductance between power and gate loops, the power and gate loops are laid out perpendicular to each other, and a via next to the source pad closest to the gate pad is used as Kelvin connection for the gate driver return path.

The [EPC90143 Half-Bridge Development Board Using EPC2305](#) implements our recommended vertical inner layout.

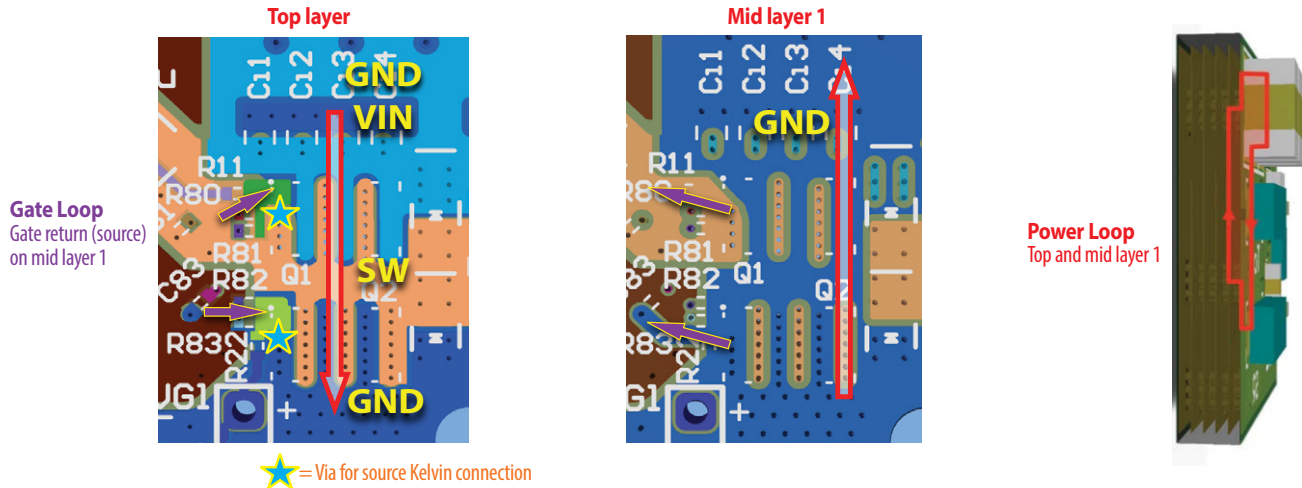


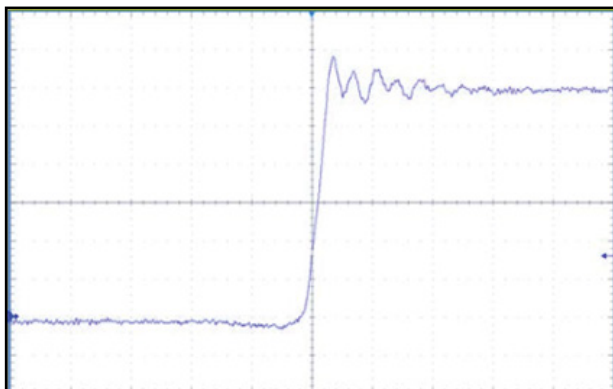
Figure 14: Inner vertical layout for power and gate loops from EPC90143

Detailed recommendations on layout can be found on EPC's website: [Optimizing PCB Layout with eGaN FETs.pdf](#)

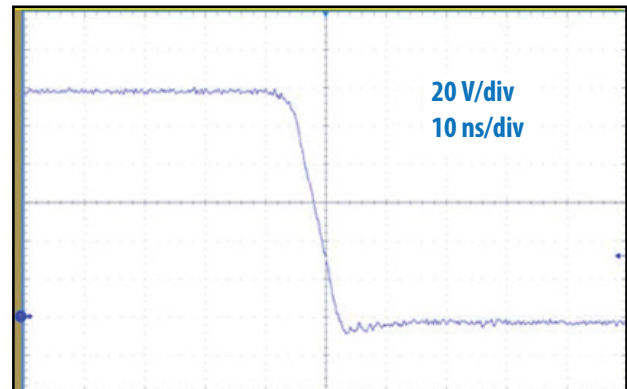
## TYPICAL SWITCHING BEHAVIOR

The following typical switching waveforms are captured in these conditions:

- **EPC90143: 150 V, 25 A Half-bridge Development Board**
- Gate driver: NCP51820 with 2.5  $\Omega$ /5  $\Omega$  Pull-Down/Pull-Up Resistance
- External  $R_{G(ON)} = 3.3 \Omega$ ,  $R_{G(OFF)} = 0.47 \Omega$
- $V_{IN} = 120 \text{ V}$ ,  $I_L = 30 \text{ A}$



Typical turn ON: 35 V/ns



Typical turn OFF: 14 V/ns

Figure 15: Typical half-bridge voltage switching waveforms

See the [EPC90143 Half-Bridge Development Board Using EPC2305 Quick Start Guide](#) for more information.

## TYPICAL THERMAL CONCEPT

The EPC2305 can take advantage of dual sided cooling to maximize its heat dissipation capabilities in high power density designs. **Note that the top of EPC FETs are connected to source potential, so for half-bridge topologies the Thermal Interface Material (TIM) needs to provide electrical isolation to the heatsink.**

Recommended best practice thermal solutions are covered in detail in [How2AppNote012 - How to Get More Power Out of an eGaN Converter.pdf](#).

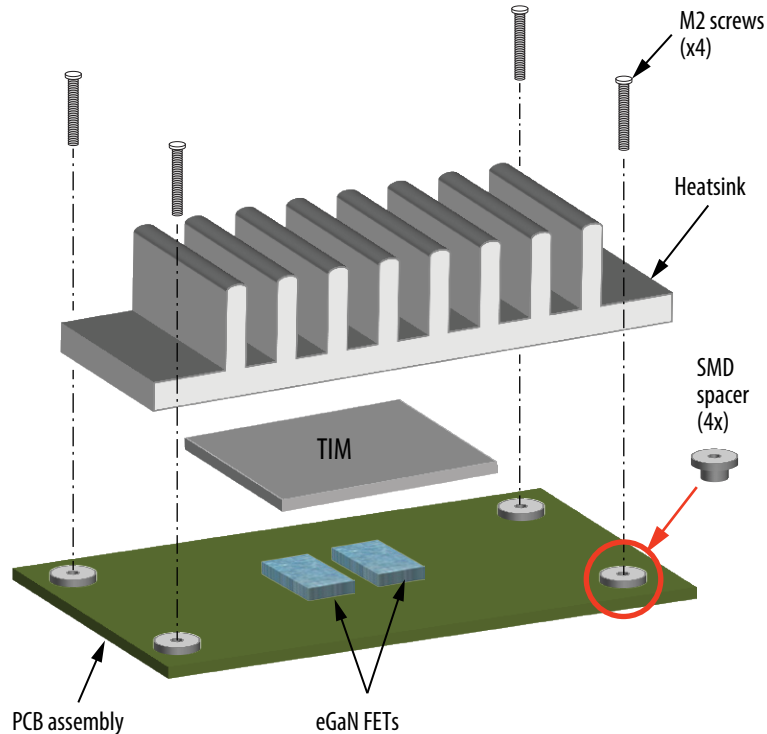


Figure 16: Exploded view of heatsink assembly using screws

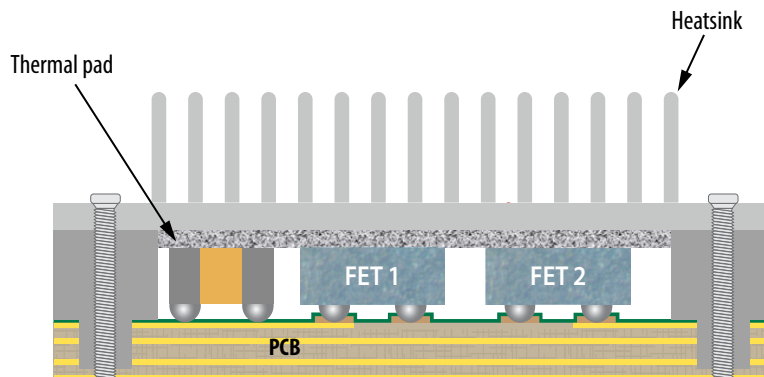
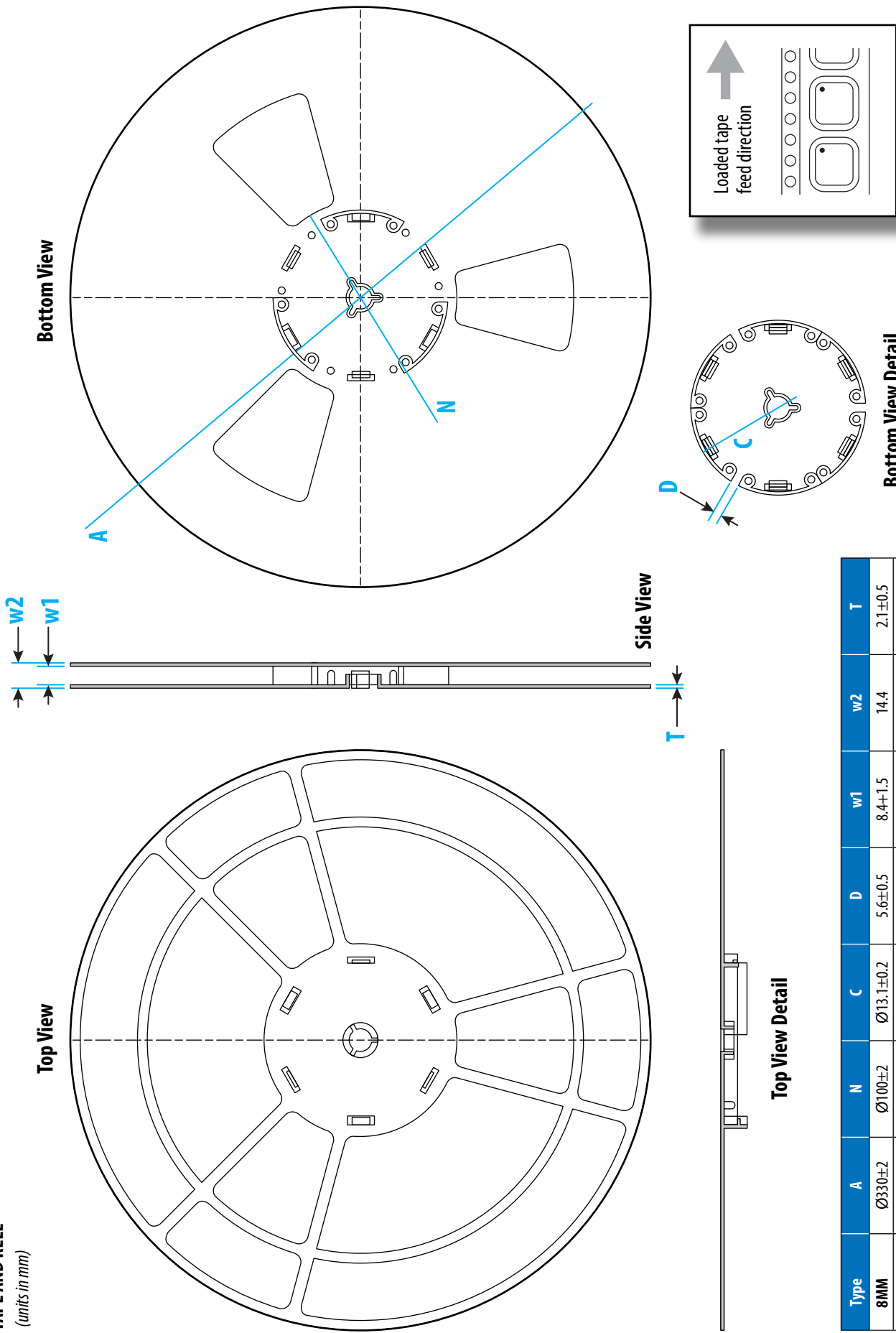


Figure 17: A cross-section image of dual sided thermal solution

**Note: Connecting the heatsink to ground is recommended and can significantly improve radiated EMI**

The thermal design can be optimized by using the [GaN FET Thermal Calculator](#) on EPC's website.

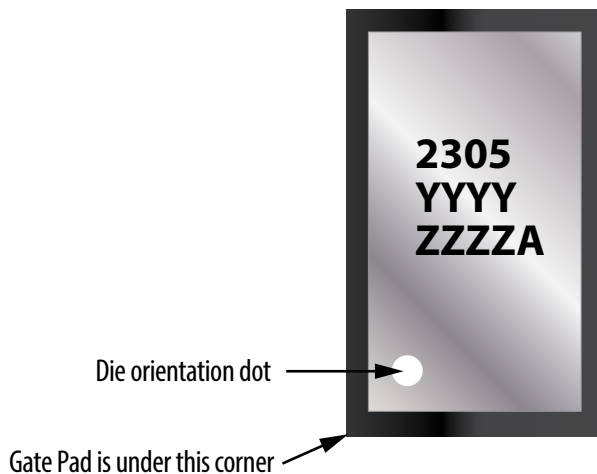
**TAPE AND REEL**  
(units in mm)



Type	A	N	C	D	w1	w2	T
8MM	Ø330±2	Ø100±2	Ø13.1±0.2	5.6±0.5	8.4±1.5	14.4	2.1±0.5
12MM	Ø330±2	Ø100±2	Ø13.1±0.2	5.6±0.5	12.4±1.5	18.4	2.1±0.5
16MM	Ø330±2	Ø100±2	Ø13.1±0.2	5.6±0.5	16.4±1.5	22.4	2.1±0.5
24MM	Ø330±2	Ø100±2	Ø13.1±0.2	5.6±0.5	24.4±1.5	30.4	2.1±0.5

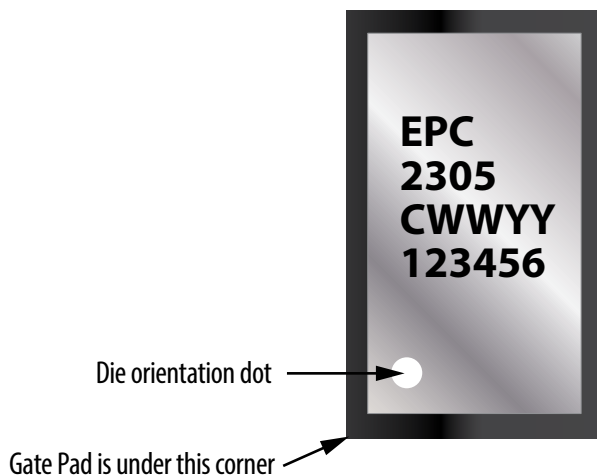


**QFN Markings (label date code 2424 onward)**

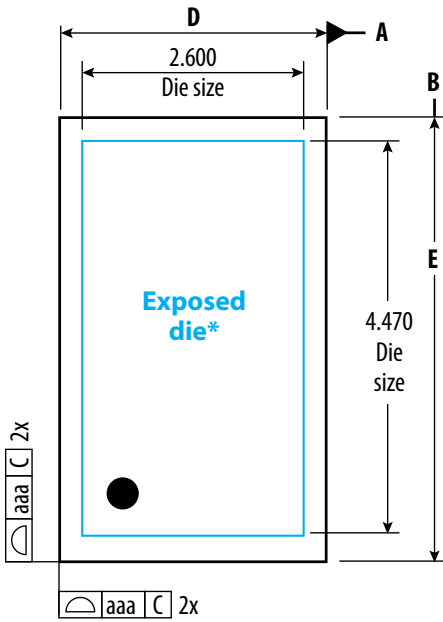
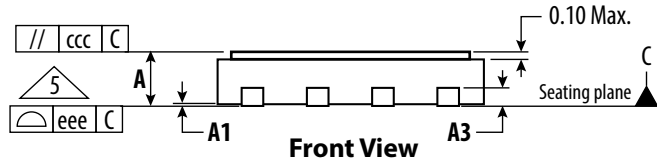
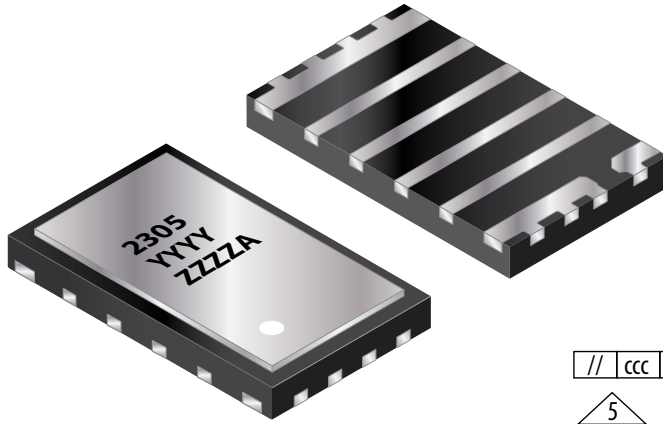


Part Number	Laser Markings		
	Part # Marking Line 1	Lot_Date Code Marking Line 2	Lot_Date Code Marking Line 3
EPC2305	2305	YYYY	ZZZZA

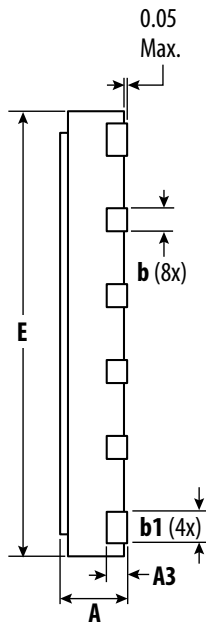
**Marking prior to label date code 2424**



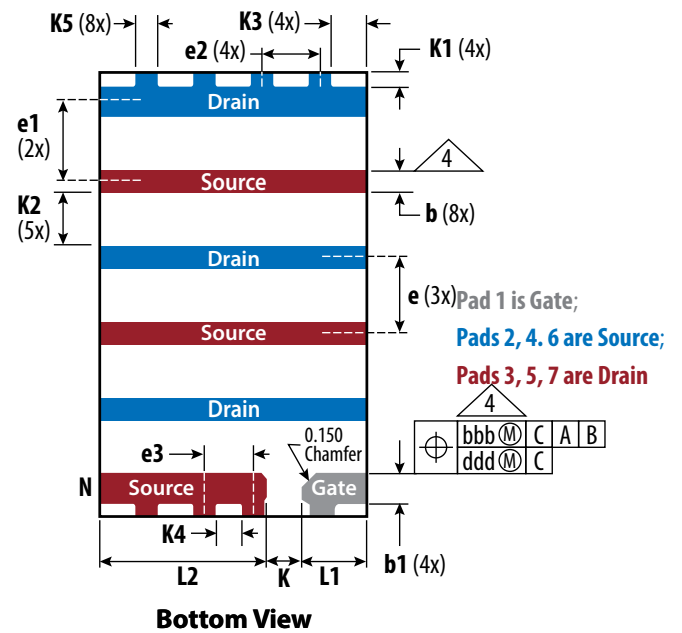
Part Number	Laser Markings			
	Company Name Marking Line 1	Part # Marking Line 2	Site_Date Code Marking Line 3	Lot_Code Marking Line 4
EPC2305	EPC	2305	CWWYY	123456



Top View



Side View



Bottom View

\*The exposed die is the silicon substrate that is internally connected to the source. It is not recommended to use it as an electrical connection

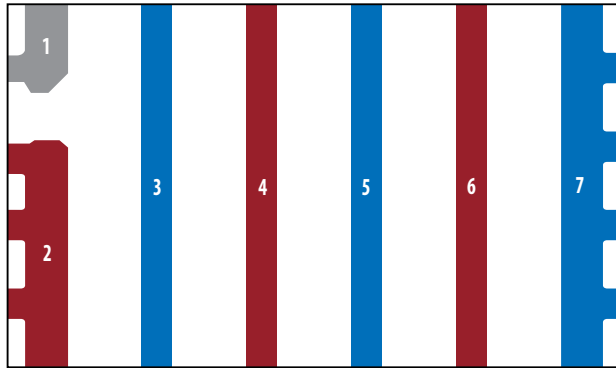
SYMBOL	Dimension (mm)			Note
	MIN	Nominal	MAX	
A			0.70	
A1	0.00	0.02	0.05	
A3			0.25	
b	0.20	0.25	0.30	4
b1	0.30	0.35	0.40	4
D	2.90	3.00	3.10	
E	4.90	5.00	5.10	
e		0.85 BSC		
e1		0.90 BSC		
e2		0.65 BSC		
e3		0.55 BSC		
L1	0.625	0.725	0.825	
L2	1.775	1.875	1.975	

SYMBOL	Dimension (mm)			Note
	MIN	Nominal	MAX	
K		0.40 Ref		
K1		0.15 Ref		
K2		0.60 Ref		
K3		0.40 Ref		
K4		0.30 Ref		
K5		0.25 Ref		
aaa		0.05		
bbb		0.10		
ccc		0.10		
ddd		0.05		
eee		0.08		
N		7		3

Notes:

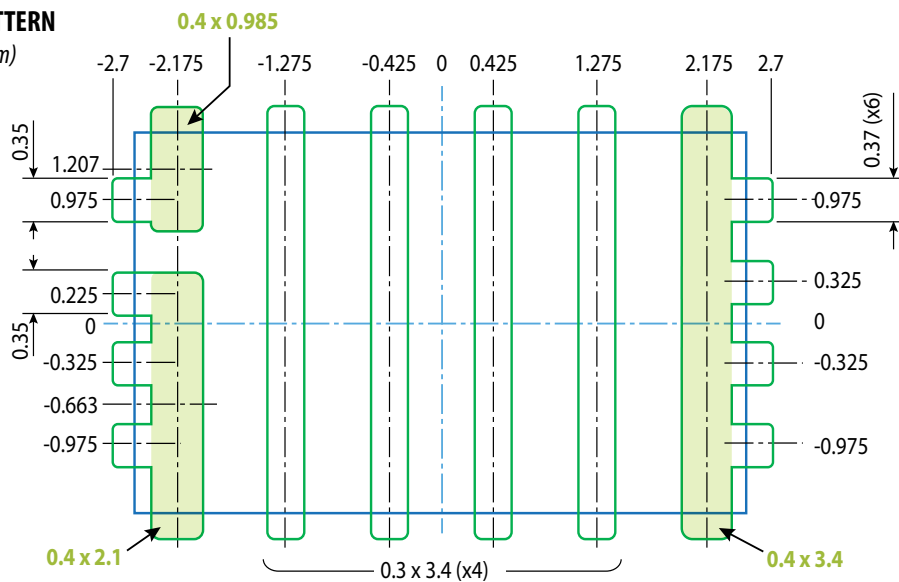
1. Dimensioning and tolerancing conform to ASME Y14.5-2009
2. All dimensions are in millimeters
3. **N** is the total number of terminals
4. Dimension **b** applies to the metallized terminal and a radius on the other end of it, dimension **b** should not be measured in that radius area.
5. Coplanarity applies to the terminals and all the other bottom surface metallization.

**TRANSPARENT VIEW**



PIN	DESCRIPTION
1	Gate
2	Source
3	Drain
4	Source
5	Drain
6	Source
7	Drain

**RECOMMENDED LAND PATTERN**  
(units in mm)



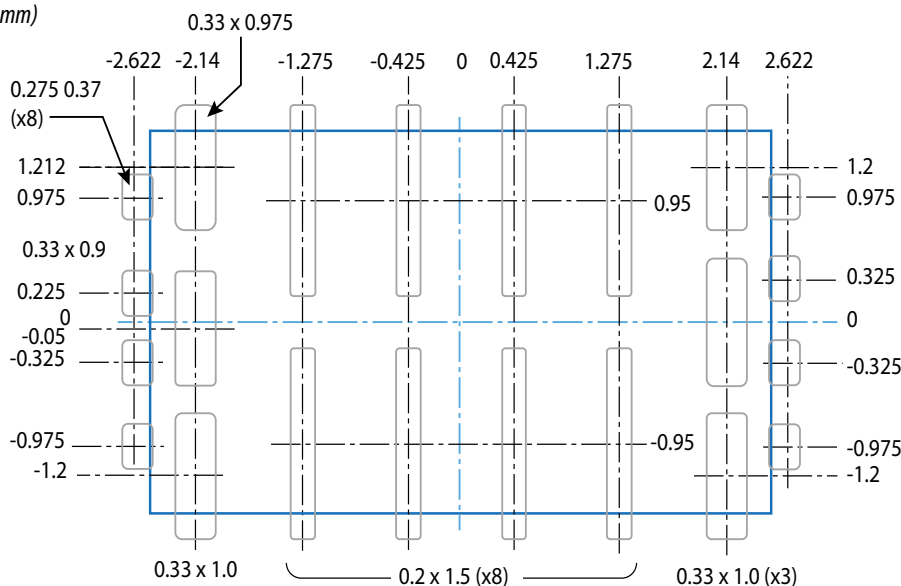
Legend:

Part outline  
Mask Opening

Radius = 0.05

Land pattern is solder mask defined.

**RECOMMENDED STENCIL DRAWING**  
(units in mm)

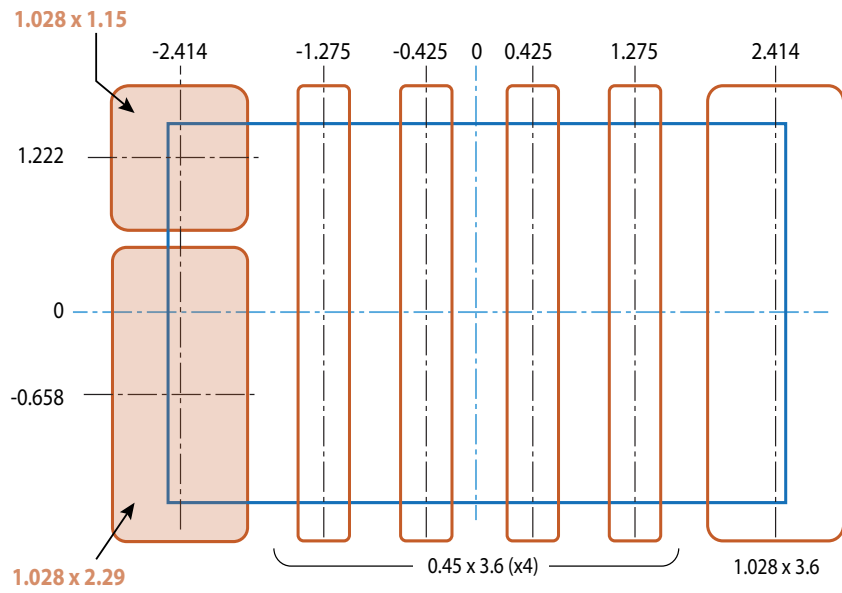


Recommended stencil should be 4 mil (100 μm) thick, must be laser cut, openings per drawing. Intended for use with SAC305 Type 4 solder, reference 88.5% metals content.

The corner has a radius of 0.1.

Split stencil design can be provided upon request, but EPC has tested this stencil design and not found any scooping issues.

**RECOMMENDED  
COPPER DRAWING**  
*(units in mm)*



Legend:  
**Part outline**  
**Copper**  
 Radius = 0.05

**3D COMPOSITE**

Legend:

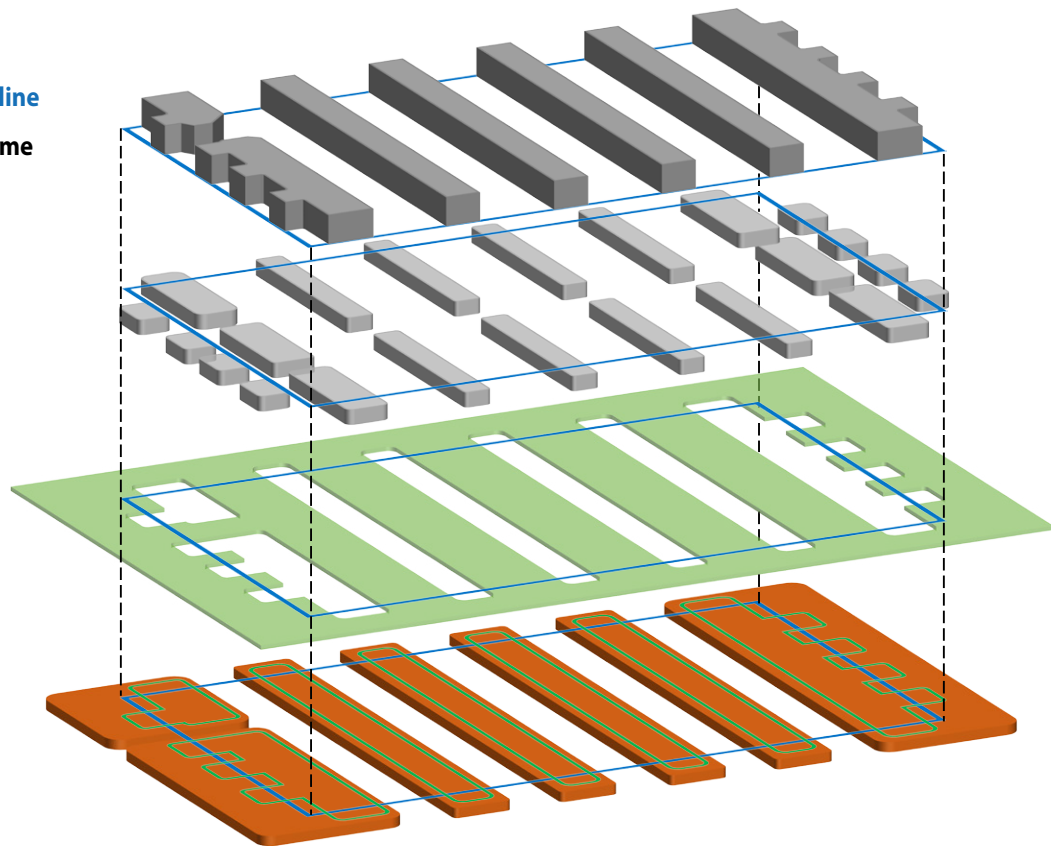
**Part outline**

**Lead frame**

**Paste**

**Mask**

**Copper**



**ADDITIONAL RESOURCES AVAILABLE**

Solder mask defined pads are recommended for best reliability.

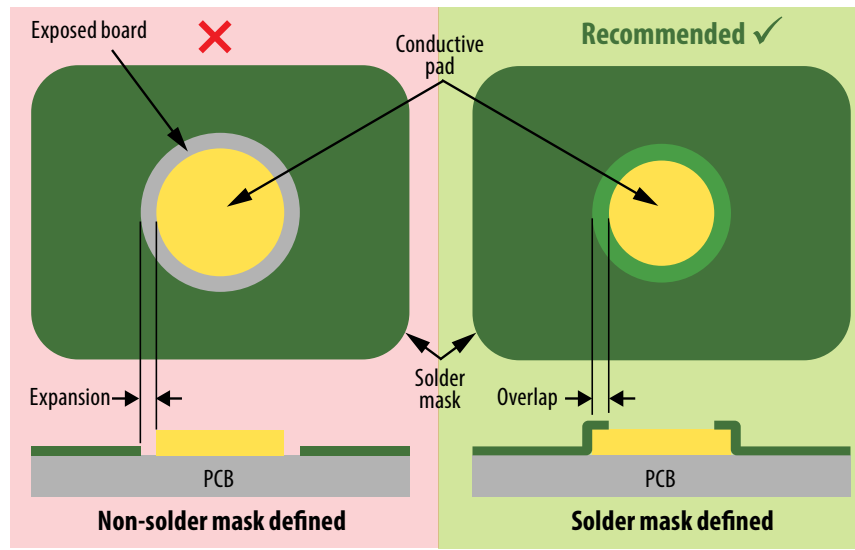


Figure 18: Solder mask defined versus non-solder mask defined pad

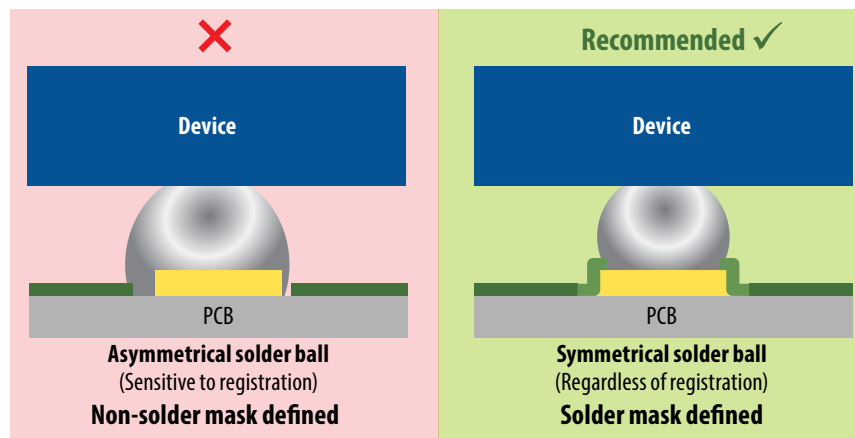


Figure 19: Effect of solder mask design on the solder ball symmetry

- Assembly resources – [https://epc-co.com/epc/Portals/0/epc/documents/product-training/Appnote\\_GaNassembly.pdf](https://epc-co.com/epc/Portals/0/epc/documents/product-training/Appnote_GaNassembly.pdf)
- Library of Altium footprints for production FETs and ICs – <https://epc-co.com/epc/documents/altium-files/EPC%20Altium%20Library.zip>  
(for preliminary device Altium footprints, contact EPC)

Efficient Power Conversion Corporation (EPC) reserves the right to make changes without further notice to any products herein to improve reliability, function or design. EPC does not assume any liability arising out of the application or use of any product or circuit described herein; neither does it convey any license under its patent rights, nor the rights of others.

eGaN® is a registered trademark of Efficient Power Conversion Corporation.

EPC Patent Listing: <https://epc-co.com/epc/about-epc/patents>

Information subject to change without notice.