

Evaluation Board EPC9165 Quick Start Guide

*2 kW 48 V/14 V 140 A Bi-Directional Power Module
Evaluation Board*

January 31, 2022

Version 1.0



DESCRIPTION

The EPC9165 evaluation power module is designed for 48 V to/from 14 V DC-DC applications. It features the EPC2302 – enhancement mode eGaN® field effect transistors (FETs). The compatible controller module (EPC9528) includes the Microchip dsPIC33CK256MP503 16-bit digital controller. The various functional blocks are shown in figure 1.

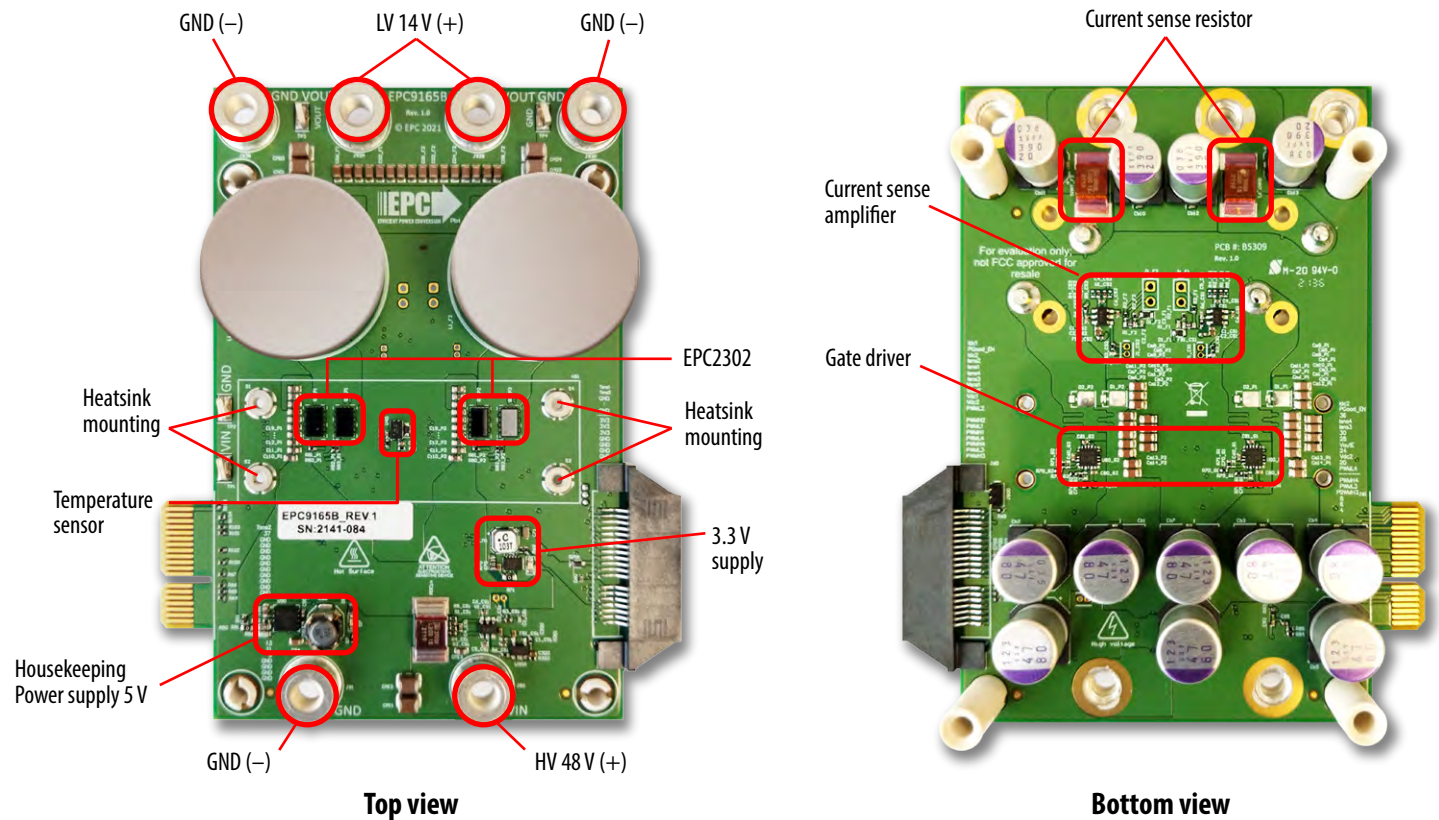

Top view

Bottom view

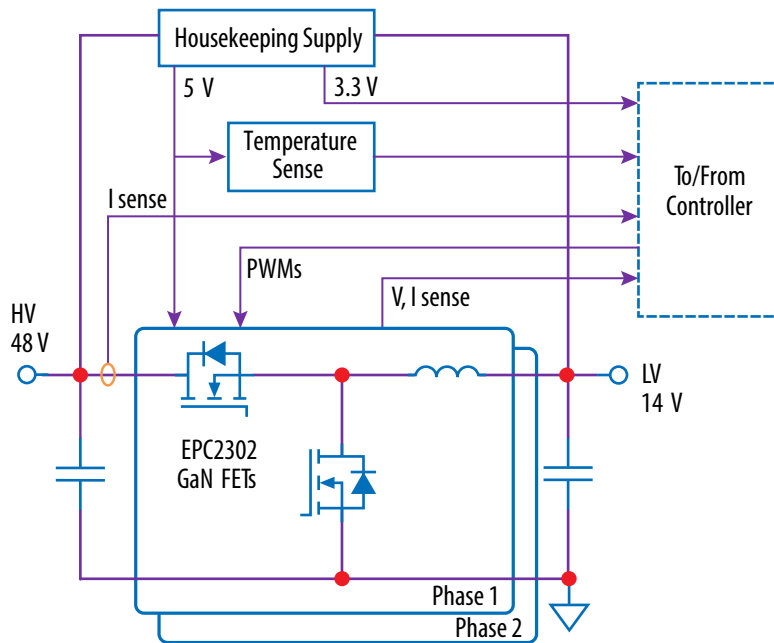
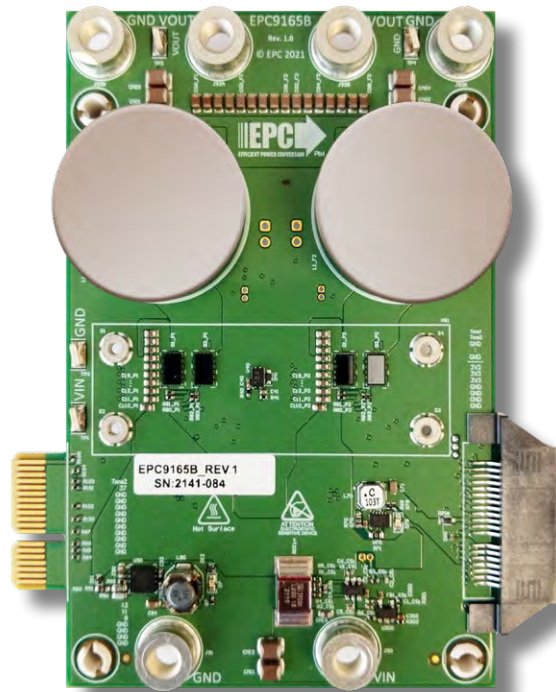

Figure 1: Functional block diagram overview of the EPC9165 board

MAIN FEATURES

- High efficiency: 96.1% @ 14.3 V/140 A output (buck)
- Dimension: 108 x 70 x 40 mm [4.3 x 2.8 x 1.6 in]
- Two-phase power stage with 100 V rated EPC2302
- Designed switching frequency: 500 kHz
- Re-programmable – Average current mode control (default)
- On board current sensor and temperature sensor
- Fault protection:
 - o Input undervoltage
 - o Input overvoltage
 - o Regulation error
 - o Inductor overcurrent
 - o Overtemperature



EPC9165 evaluation board

RECOMMENDED OPERATING CONDITIONS

Table 1: Electrical Specifications (T_A = 25°C) EPC9165

Symbol	Parameter	Conditions	Min	Nom	Max	Units
V _{IN}	Input Voltage	Buck	20	48	60	V
		Boost, during operation	11.3	14	16	
		Boost, start up	12.3			
V _{IN,on}	Input UVLO turn on voltage	Buck		20		V
		Boost		12.3		
V _{IN,off}	Input UVLO turn off voltage	Buck		17.5		V
		Boost		11.3		
V _{OUT}	Output Voltage	Buck	5	14.3	16	V
		Boost	20	48	50	
t _{OUT,rise}	Output voltage rise time			100		ms
ΔV _{OUT}	Output voltage ripple	Buck, I _{OUT} = 21 A		40		mV
		Boost, I _{OUT} = 6 A		250		
I _{OUT,BUCK}	Buck Output Current	Buck	0		140	A
I _{IN,BOOST}	Boost Input Current	Boost	0		140	
I _{MAX}	Maximum current limit threshold	Buck, output current	145		150	
		Boost, input current	145		150	
T _{MAX}	Maximum temperature limit threshold	During operation	93		98	°C
T _{Start,MAX}	Maximum temperature to start converter	After over-temperature fault event			80	
f _S	Switching frequency			500		kHz

HIGHLIGHTED COMPONENTS AND FUNCTIONS

Power Stage

The EPC9165 features four 100 V, 1.8 mΩ EPC2302 GaN FETs. The datasheet should be read in conjunction with this quick start guide. For more information on EPC2302 please refer to the datasheet available from EPC at www.epc-co.com.

Housekeeping supply

The EPC9165 includes logic power supplies for 5 V and 3.3 V. It also supplies power to the controller card through the edge connector J60.

Current and voltage sense

The output inductor current and input current are all measured using 0.2 mΩ sensing resistor and 50 V/V amplifier. Therefore, the current sense gain is 0.01 V/A. Input and output voltages are measured using resistor divider network (100 k and 5.36 k), the gain is 0.05087.

Temperature sensor

An AD590 temperature sensor is located under the heatsink. It has a 3.48 k load resistor, therefore the output voltage V_o [V] vs. temperature T [°C] follows the equation:

$$V_o = \left(\frac{3.48}{1000} \right) T + 0.95$$

LED indicators

There are two LEDs indicating the status of the housekeeping supply:

- 5 V LED (orange) – indicates the 5 V supply is operational
- 3.3 V LED (yellow) – indicates the 3.3 V supply is operational

Test points and measurement setup

A number of test points are available for easy measurement of various nodes as follows:

- SMD hookup for high voltage (HV) terminals TP1 and TP2
- SMD hookup for low voltage (LV) terminals TP3 and TP4
- Voltage loop gain injection/measurement point J1_F1
- Current loop gain injection/measurement point J1_CS1 and J1_CS2

All signals are measured with respect to ground (GND). All the test point locations are shown in figure 2.

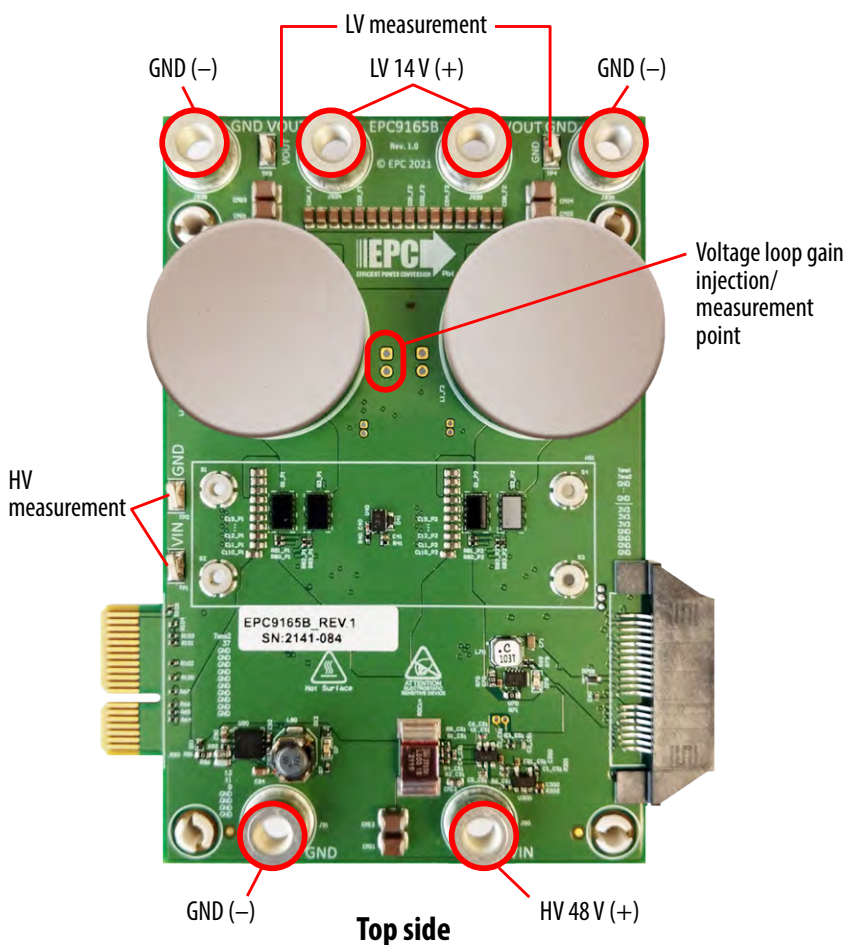

Figure 2: EPC9165 test point pad and hookup locations and designations

OPERATING CONSIDERATIONS

Buck/Boost Modes

The module is programmed with Buck mode by default. To operate as a boost converter, please download the firmware for boost mode and re-program the control module.

Over-current protection

If the load current exceeds a pre-determined maximum setpoint, this condition will be regarded as a fault condition and the converter will shut down. The converter will then attempt to restart after 2 seconds. This shut down and restart cycle will continue until the over-current condition clears.

Over-temperature protection

During operation, if the heatsink base temperature (sensed by AD590) exceeds 95°C, the over-temperature fault condition will be set, and the converter will shut down. After the temperature drops to below 80°C, the converter will be able to restart.

Compatible Controllers

A list of compatible controllers for the EPC9165 is given in table 2.

Table 2: Compatible controller interface and controller boards to the EPC9165

Controller Board Number	Controller Manufacturer	Controller	Target Application
EPC9528 Rev. 3.0	Generic controller board	dsPIC33CK256MP503	DC-to-DC converter

Please refer to [EPC9528 Quick Start Guide](#) for more information about the control module with Microchip dsPIC33CK256MP503.

The average current mode control (ACMC) is used for EPC9165.

Jumper J800

The jumper J800 is located next to the EPC9528 edge connector. The default setting is left floating. It is possible to route the output of power good (PGood) signal of the 3.3 V regulator to the controller by connecting top two pins together, as shown in figure 3. While not implemented, this can be used as the enable signal for the controller.

The other jumper position routes 5 V DC to the controller. **Do not use this setting with the EPC9528 controller.**

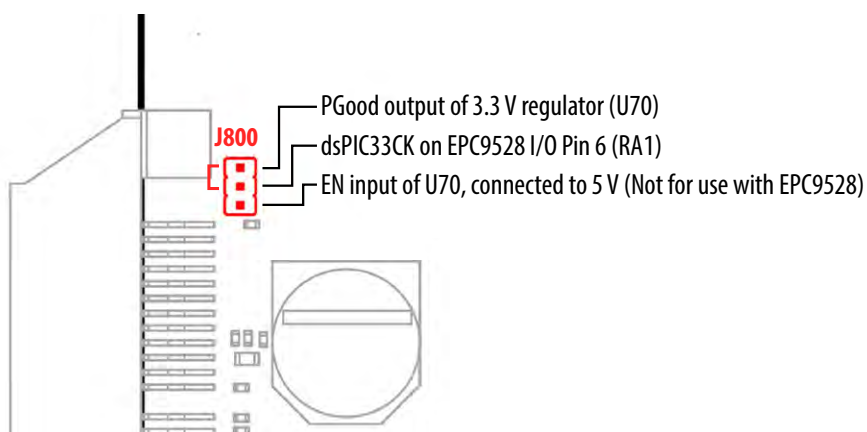

Figure 3: EPC9165 J800 jumper settings

MECHANICAL SPECIFICATIONS

Unit: mm [in]

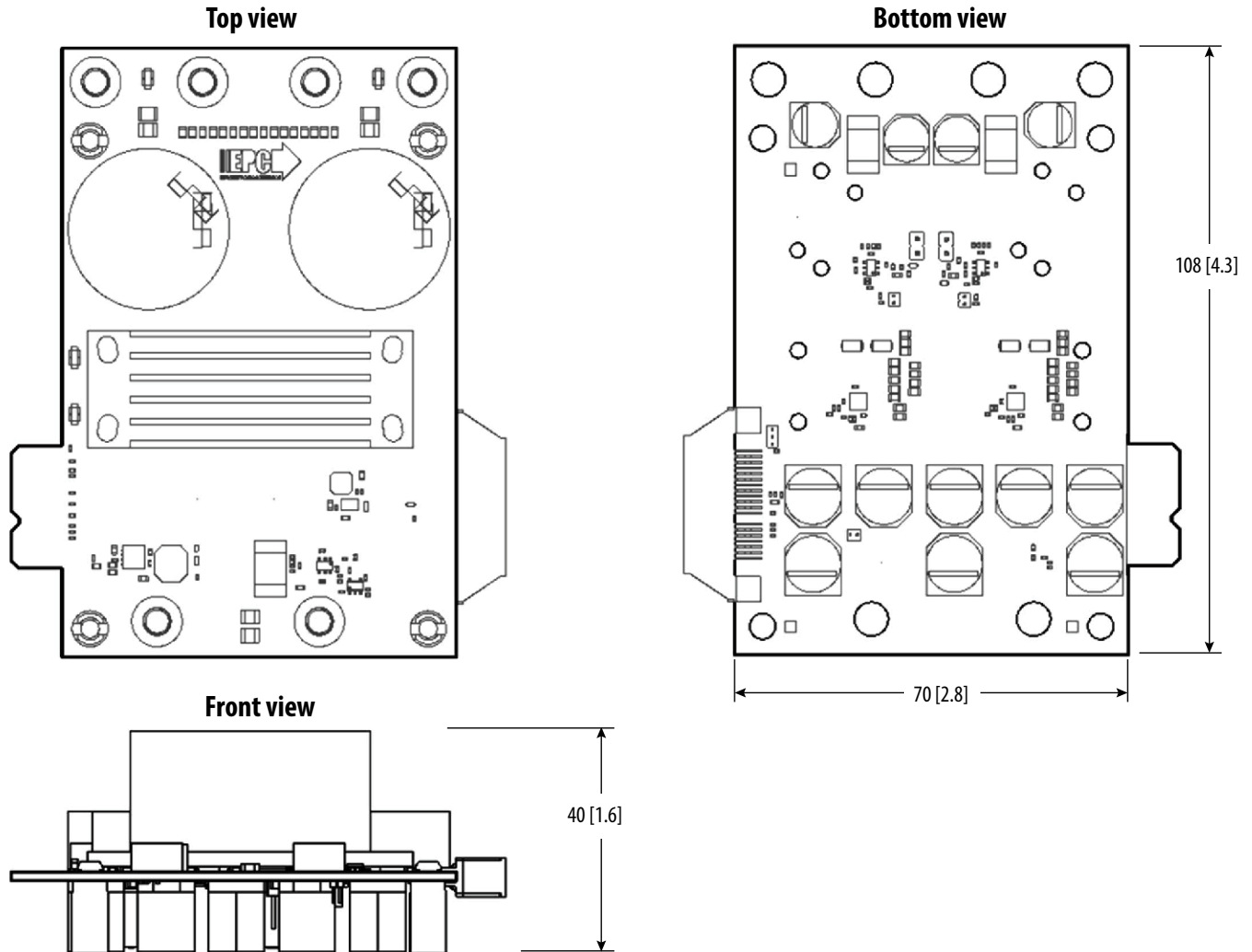

Figure 4: EPC9165 mechanical specifications

QUICK START PROCEDURE

Follow the procedure below to operate the EPC9165 as a buck/boost:

1. Program the correct firmware onto the EPC9528 controller
2. Insert the EPC9528 controller into the corresponding slot (J60) on EPC9165
3. With power off, connect input and output terminals (M5 screws) to power supply and load

Buck mode: power supply connects to HV 48V (+) and GND (-); load connects to LV 14V (+) and GND (-), as shown in figure 2.

Boost mode: power supply connects to LV 14V (+) and GND (-); load connects to HV 48V (+) and GND (-), as shown in figure 2.

4. Turn on the power supply and load, and ensure voltages and currents are within specifications of table 1.
5. For shutdown, please follow the above steps in reverse.

THERMAL MANAGEMENT

Thermal management is very important to ensure proper and reliable operation. Sufficient cooling is required for this module to operate in the full specified output current range, even with heatsink installed.

Heatsink Installation

A mounted heatsink is required for effectively dissipating the generated heat to ambient. The heatsink from Wakefield 567-94AB can be mounted to the SMD threaded (M2) spacers on the board, which are 1 mm tall, leaving around 0.3 mm gap between the FETs and heatsink. High thermal conductivity TIM materials T-Global A1780 of thickness 0.5 mm provides good thermal conductance across the 0.3 mm gap. The heatsink and TIM materials (figure 5) are pre-installed and will provide adequate cooling for testing.

Configurations with higher TIM thicknesses and lower thermal conductivity degrade thermal performance and increase the thermal resistance between the FETs and the sink surface ($R_{th,JS}$). This directly translates to higher temperature rise across the TIM material which can lead to higher junction temperatures.

The choice of TIM needs to also consider the following characteristics:

- **Mechanical compliance** – During the attachment of the heat spreader, the TIM underneath is compressed from its original thickness to the vertical gap distance between the spacers and the FETs. This volume compression exerts a force on the FETs. A maximum compression of 2:1 is recommended for maximum thermal performance and to constrain the mechanical force which maximizes thermal mechanical reliability.
- **Electrical insulation** – The backside of the eGaN FET is a silicon substrate that is connected to source and thus the upper FET in a half-bridge configuration is connected to the switch-node. To prevent short-circuiting the switch-node to the grounded thermal solution, the TIM must be of high dielectric strength to provide adequate electrical insulation in addition to its thermal properties.
- **Thermal performance** – The choice of thermal interface material will affect the thermal performance of the thermal solution. Higher thermal conductivity materials is preferred to provide higher thermal conductance at the interface.

EPC recommends the following thermal interface materials:

- **t-Global** P/N: TG-A1780 x 0.5 mm (highest conductivity of 17.8 W/m·K)
- **t-Global** P/N: TG-A6200 x 0.5 mm (moderate conductivity of 6.2 W/m·K)
- **Bergquist** P/N: GP5000-0.02 (~0.5 mm with conductivity of 5 W/m·K)
- **Bergquist** P/N: GPTGP7000ULM-0.020 (conductivity of 7 W/m·K)

The pre-installed TIM is TG-A1780 X 0.5 mm. The dimensions and positions of the TIM are shown in Figure 6.

Thermal derating

Without sufficient cooling, the output current capability is reduced. The module temperature should be monitored to ensure the maximum temperature does not exceed the maximum junction specified in the datasheet.

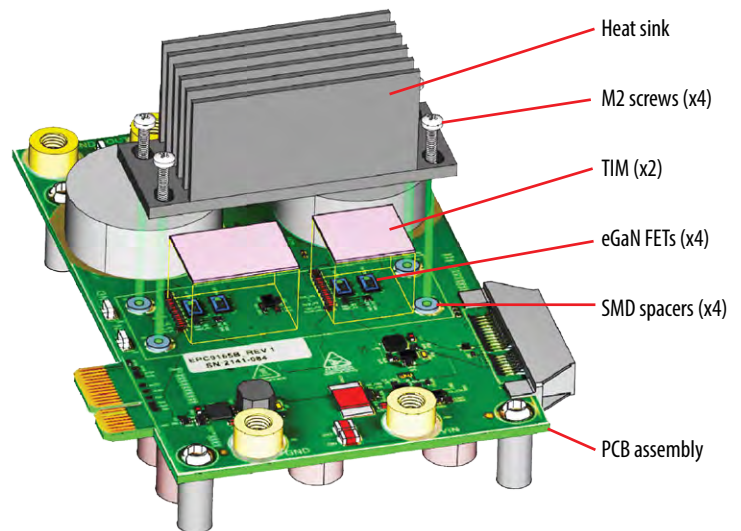

Figure 5. PCB 3D model showing TIM and heat sink installation

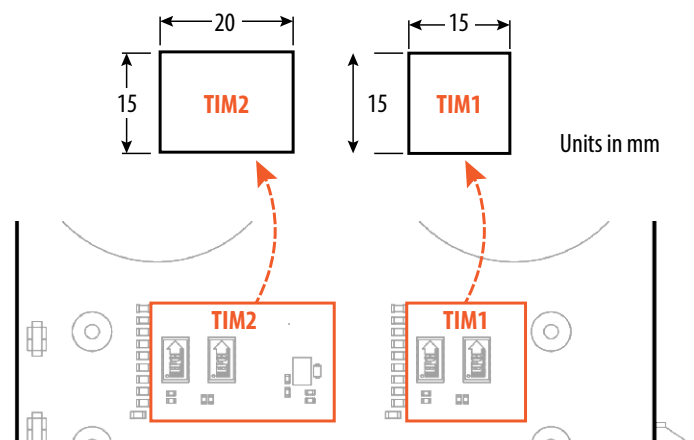
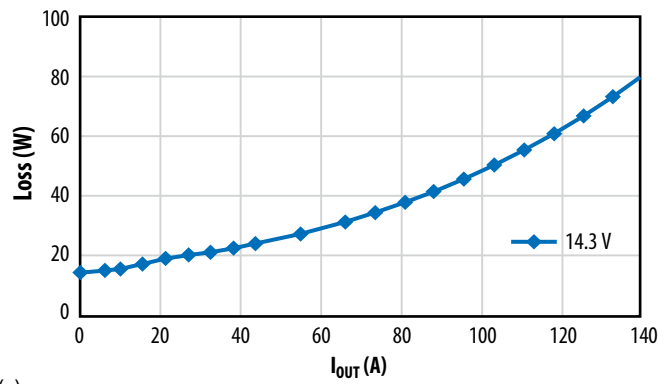
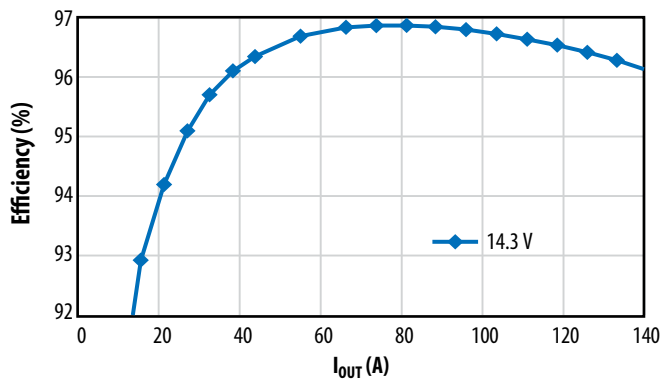
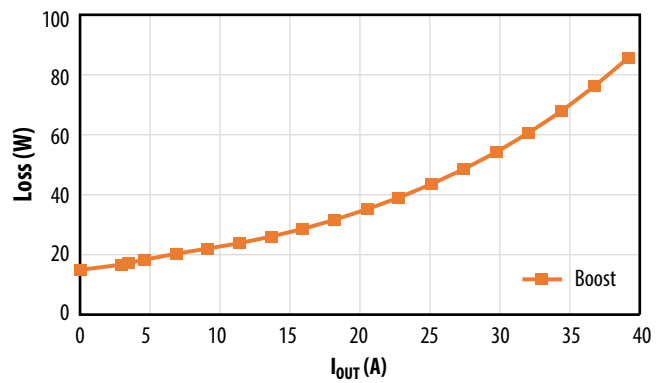
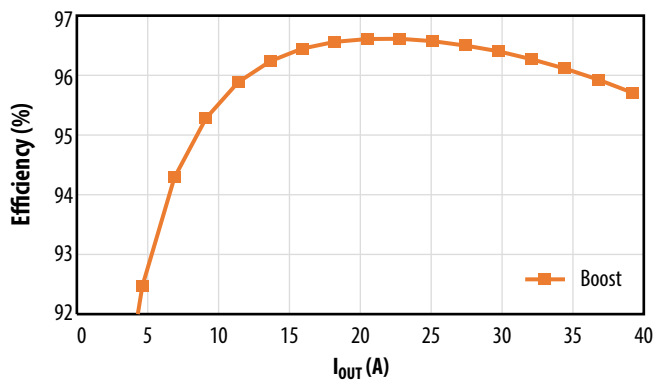

Figure 6. EPC9165 TIM specifications and location

EXPERIMENTAL VALIDATION EXAMPLE



(a)



(b)

Figure 7: EPC9165 typical efficiency and power loss, (a) buck $V_{IN} = 48\text{ V}$, (b) boost $V_{IN} = 14.3\text{ V}$, $V_{OUT} = 48\text{ V}$

Measurement Waveforms

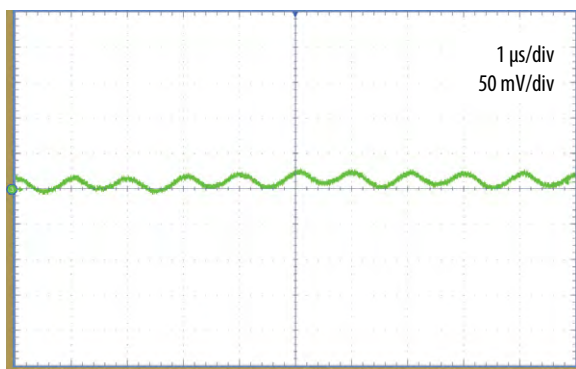

(a)

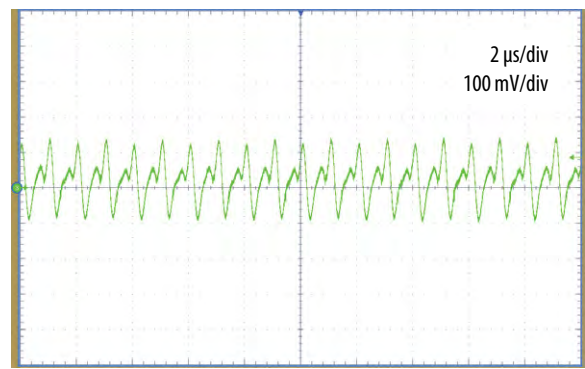

(b)

Figure 8: EPC9165 output voltage ripple (a) buck $V_{in} = 48\text{ V}$, $V_{OUT} = 14.3\text{ V}$, $I_{OUT} = 21\text{ A}$; (b) boost $V_{IN} = 14.3\text{ V}$, $V_{OUT} = 48\text{ V}$, $I_{OUT} = 6\text{ A}$.

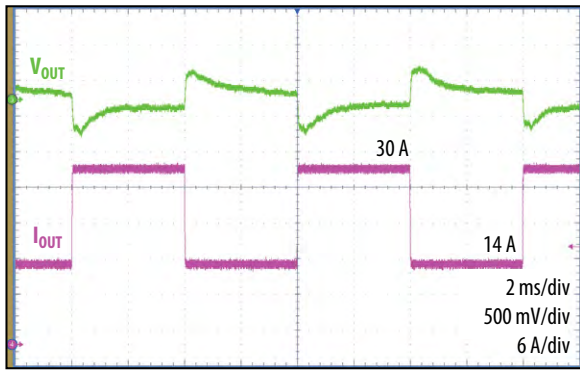

(a)

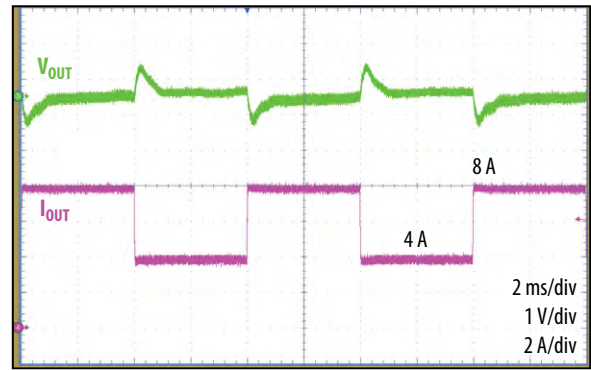

(b)

Figure 9: EPC9165 transient response (a) buck $V_{IN} = 48\text{ V}$, $V_{OUT} = 14.3\text{ V}$; (b) boost $V_{IN} = 14.3\text{ V}$, $V_{OUT} = 48\text{ V}$.

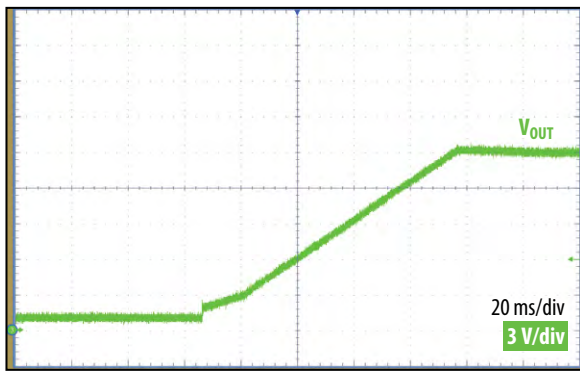

(a)

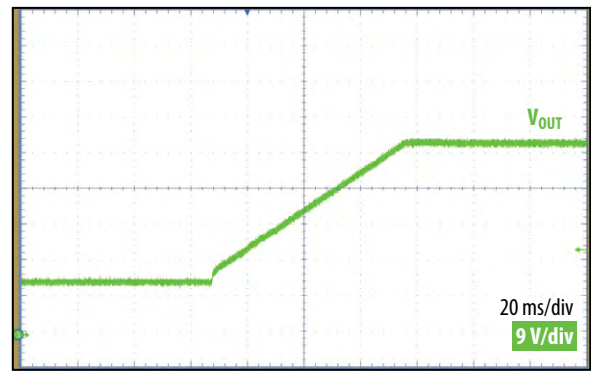

(b)

Figure 10: EPC9165 start up waveform, (a) buck $V_{IN} = 48\text{ V}$; (b) boost $V_{IN} = 14.3\text{ V}$

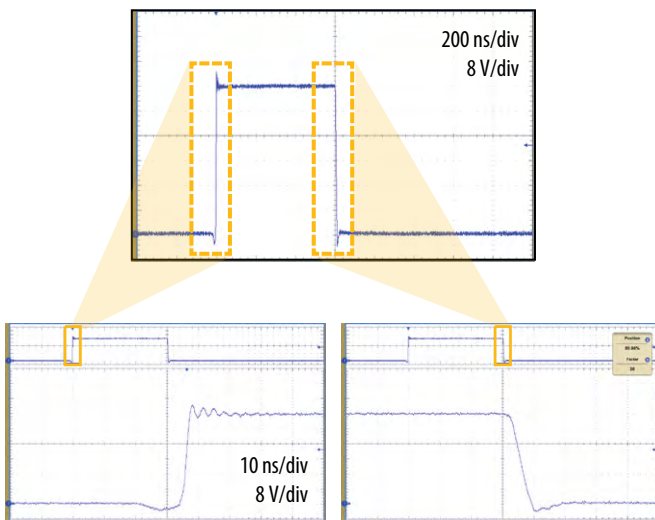

(a)

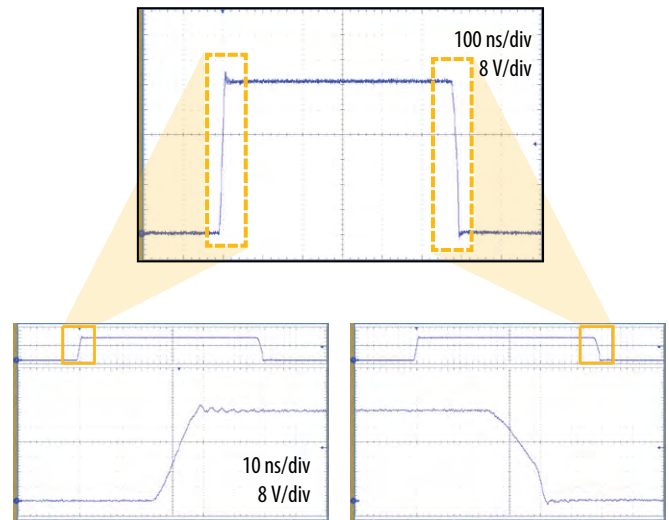

(b)

Figure 11: EPC9165 switch node waveform
(a) buck $V_{IN} = 48\text{ V}$; (b) boost $V_{IN} = 14.3\text{ V}$

THERMAL PERFORMANCE

Specification testing is performed using forced air of 2000 LFM due to the small size of the heatsink. Thermal tests reaching 1 kW per phase indicate that the operating temperature is within thermal limits with the recommended heatsink and TIM installed and with the applied forced air-cooling conditions as shown in Figure 12.

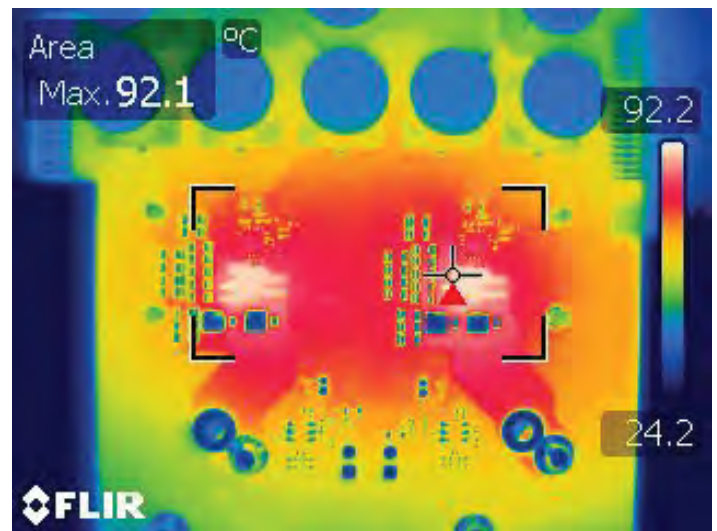

Figure 12. Thermal image showing FET region (back side of the board) temperature at full load with heatsink and 2000 LFM forced air cooling

For support files including schematic, Bill of Materials (BOM), and gerber files please visit the EPC9165 landing page at: <https://epc-co.com/epc/products/demo-boards/epc9165>

For More Information:

Please contact info@epc-co.com
or your local sales representative

Visit our website:
www.epc-co.com

Sign-up to receive
EPC updates at
bit.ly/EPCupdates



DigiKey

EPC Products are distributed through Digi-Key.
www.digikey.com

Evaluation Board Notification

The EPC9165 board is intended for product evaluation purposes only. It is not intended for commercial use nor is it FCC approved for resale. Replace components on the Evaluation Board only with those parts shown on the parts list (or Bill of Materials) in the Quick Start Guide. Contact an authorized EPC representative with any questions. This board is intended to be used by certified professionals, in a lab environment, following proper safety procedures. Use at your own risk.

As an evaluation tool, this board is not designed for compliance with the European Union directive on electromagnetic compatibility or any other such directives or regulations. As board builds are at times subject to product availability, it is possible that boards may contain components or assembly materials that are not RoHS compliant. Efficient Power Conversion Corporation (EPC) makes no guarantee that the purchased board is 100% RoHS compliant.

The Evaluation board (or kit) is for demonstration purposes only and neither the Board nor this Quick Start Guide constitute a sales contract or create any kind of warranty, whether express or implied, as to the applications or products involved.

Disclaimer: EPC reserves the right at any time, without notice, to make changes to any products described herein to improve reliability, function, or design. EPC does not assume any liability arising out of the application or use of any product or circuit described herein; neither does it convey any license under its patent rights, or other intellectual property whatsoever, nor the rights of others.