

# Demonstration Board EPC9173 Quick Start Guide

*1.5 kW, 3-phase BLDC Motor Drive Inverter using the  
EPC23101 integrated circuit*

Revised May 23, 2022

Revision 1.0

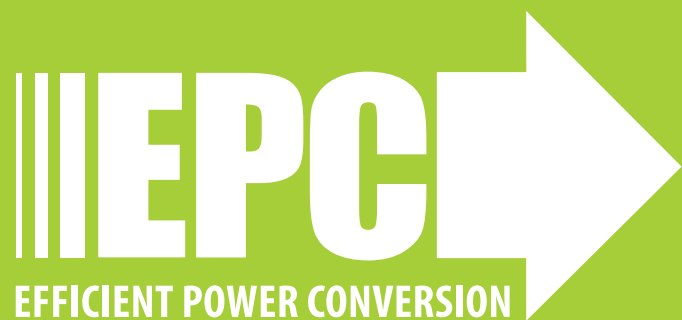

**DESCRIPTION**

The EPC9173 demonstration board is a 3-phase motor drive inverter board featuring the EPC23101 eGaN IC with embedded gate driver function and a floating power GaN FET with 3.3 mΩ maximum  $R_{DS(on)}$ , 100 V maximum voltage. Its application can be extended to a Buck, Boost, Half-Bridge, Full Bridge, or LLC Converters. The EPC9173 uses two integrated circuits for each switch position and can deliver up to 50 Apk (35 A<sub>RMS</sub>) maximum output current. The switching cell can operate up to 250 kHz PWM switching frequency given appropriate cooling. The EPC9173 contains all the necessary critical functions circuits to support a complete motor drive inverter including gate drivers, regulated auxiliary power rails for housekeeping supplies, voltage, and temperature sense, accurate current sense, and protection functions. The various functional blocks are shown in Figure 1. The EPC9173 mates with an assortment of compatible controllers, supported by various manufacturers leveraging existing resources for quick development purposes, that can quickly be configured as a motor drive inverter or DC–DC converter.

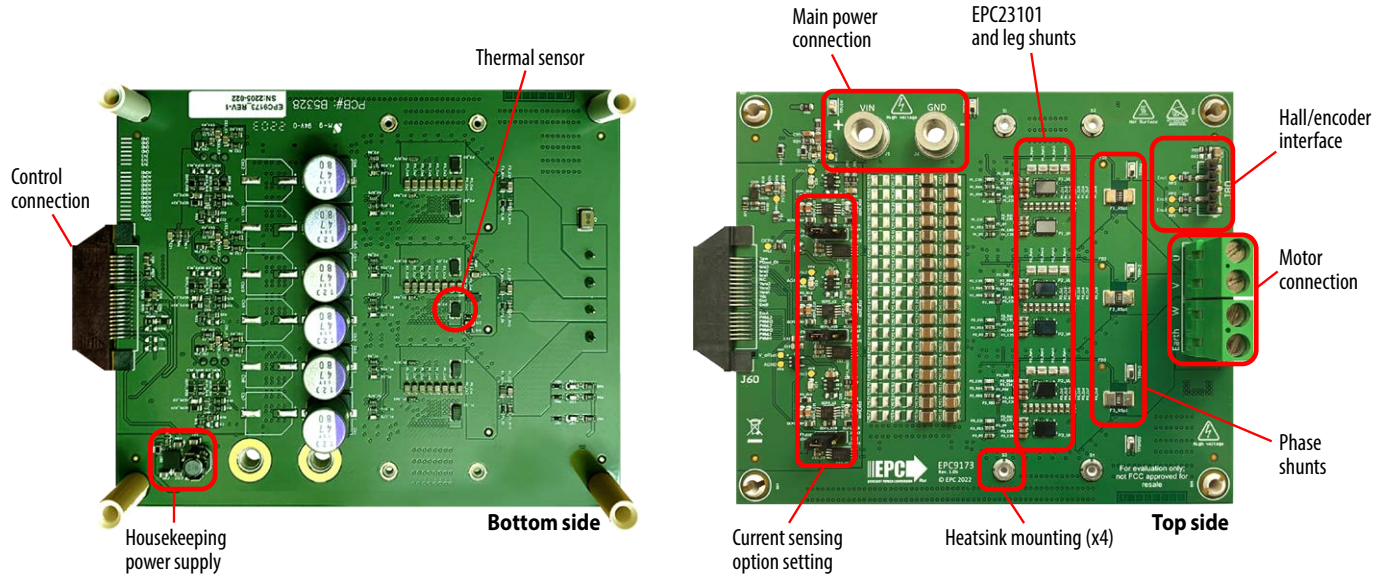

Figure 1: Photo overview of the EPC9173 board highlighting the main sections

A functional block diagram of the EPC9173 demonstration board is shown in figure 2 that details the phase current sense, phase and DC voltage sense, the half-bridge power stages, housekeeping power supply and controller interface connection.

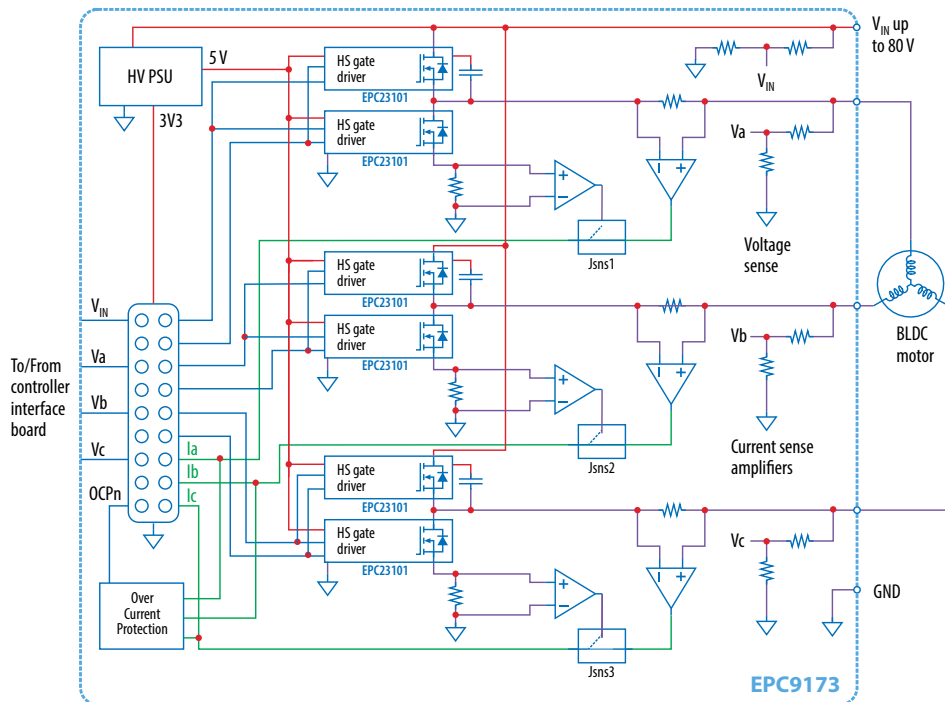
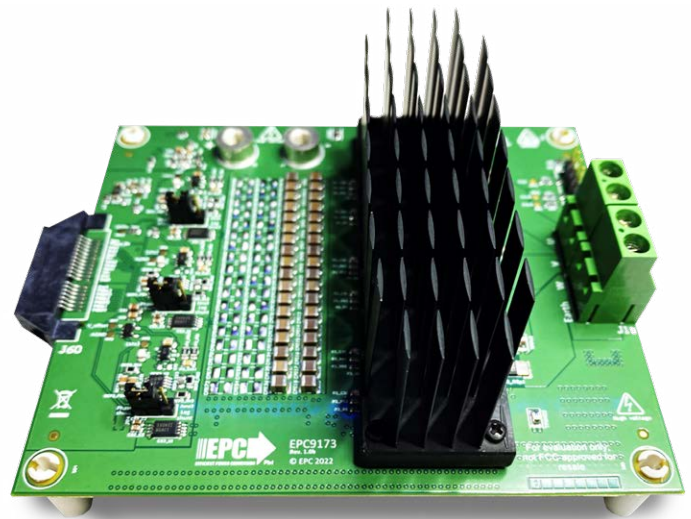

Figure 2. Block diagram of EPC9173 board in BLDC drive example application.

## MAIN FEATURES

3-phase inverter based on EPC23101 eGaN FET with wide input DC voltage ranging from 14 V to 60 V

- Dimensions: L x W = 130 x 100 mm (including connector)
- Low distortion switching that keeps motor audio emission low and reduces torque ripple
- dv/dt optimized for motor drives less than 10 V/ns with option to increase dv/dt for DC-DC applications
- All current sense with high accuracy and bandwidth (option to choose between in-line and leg shunt current sensors)
- All phases voltage sense
- Voltage sense for the DC supply to the drive
- Housekeeping power for the various circuits and external controller derived from the main power supply to the EPC9173
- Temperature monitoring circuit
- Protection features including: over-current and input supply under voltage lockout
- Shaft encoder/Hall sensors interface connector for motor drive application with two voltage levels selection option
- The board can also be configured to operate as a synchronous buck DC-DC converter.



EPC9173 Demonstration board with heatsink attached

## RECOMMENDED OPERATING CONDITIONS

Table 1: Electrical Specifications (T<sub>a</sub> = 25°C) EPC9173

Symbol	Parameter	Conditions	Min	Nom	Max	Units
V <sub>IN</sub>	Input supply voltage		20		85	V
I <sub>Phase</sub>	EPC9173 Phase current <sup>(1)</sup>				35	A <sub>RMS</sub>
f <sub>sw</sub>	Switching frequency				250 <sup>(4)</sup>	kHz
V <sub>IN_uvlo</sub>	Input undervoltage lockout voltage			8		V
V <sub>IN_uvlo_hys</sub>	Input undervoltage lockout voltage hysteresis			1.73		
V <sub>IH</sub>	PWM high-level logic threshold	PWM rising edge	2.4			
V <sub>IL</sub>	PWM low-level logic threshold	PWM falling edge			0.8	
V <sub>IHyst</sub>		V <sub>IH</sub> Rising – V <sub>IL</sub> Falling		0.3		
R <sub>in</sub>	PWM input pulldown resistance			6.5		kΩ
PW <sub>min</sub>	Minimum input pulse -width	50% level to 50% level – based on gate driver specs		20		ns
t <sub>Prop_delay</sub>	PWM input to Switch-node transition delay	High-side/Low-side on/off		20		
V <sub>Isns_range</sub>	Phase current sense voltage dynamic range	-Imax; +Imax	0		3.3	V
I <sub>Isns_range</sub>	Phase current sense dynamic range	Shunt = 1.0 mΩ, current sense amplifier gain = 20	-82.5		82.5	A
I <sub>ovc</sub> <sup>(2)</sup>	Positive over-current threshold	Over-current circuits detects both positive negative OVC		50		V
V <sub>Isns_offset</sub>	Amplified current sense signal offset voltage	Shunt = 1.0 mΩ, current sense amplifier gain = 20, I <sub>phase</sub> = 0 A		1.65		V
G <sub>Isns</sub>	Amplified current sense gain	Shunt = 1.0 mΩ, current sense amplifier gain = 20. V <sub>Isns</sub> – V <sub>Isns_offset</sub> is positive when current enters the inverter		1		mV/A
G <sub>Vsns</sub>	Phase and DC voltage sense gain <sup>(3)</sup>			34.3		mV/V

(1) Maximum current depends on die temperature – actual maximum current is affected by switching frequency, bus voltage and thermal cooling. Refer to thermal performance section in this guide and to [EPC23101 data sheet](#) for details.

(2) All phases over-current is monitored. Over-current signal is sent to the controller connector via R60.

(3) **Maximum dynamic voltage range is 0 V to 81.5 V which exceeds maximum recommended supply voltage for the EPC9173 reference design board.**

(4) Higher frequency operation up to 500 kHz in DC-DC mode is possible.

## HIGHLIGHTED PARTS

### Power Stage

The EPC9173 features a 3-phase inverter with EPC23101 eGaN integrated circuits. For more information on the EPC23101 please refer to the datasheet available from EPC at [www.epc-co.com](http://www.epc-co.com). The datasheet should be read in conjunction with this quick start guide.

### Onboard power supply

The EPC9173 board includes logic and gate driver house-keeping power supplies that are powered from the main input supply voltage to the inverter board. The 3.3 V controller supply voltage is also provided to the controller connector (J60) and can be disconnected by removing a resistor (R803).

### Current and voltage sense

The EPC9173 inverter is equipped with voltage and current sense for all phases and voltage sense for the DC input.

Output current is measured in-line using a 1.0 mΩ shunt (RSp1) that is amplified using the INA240A1PWR (CSx\_U1) bi-directional current sense amplifier that yields a total gain of 20 mV/A. The bandwidth of the current sense amplifier is 400 kHz which is adequate for accurate motor control operation at 100 kHz switching frequency.

The output current can be also measured using 4x 4.0 mΩ leg shunts (equivalent to 1.0 mΩ leg shunt) that are amplified with a total gain of 20 mV/A and an offset of 1.65 V. By inserting the jumper (Jsnsx) in the proper position, the user can choose seamlessly between in-phase or leg shunt current sensing. In all configurations, the shunt amplifiers are bi-directional ensuring the full four-quadrant operation is covered.

The main input DC supply voltage and each phase voltage are measured using a resistor divider network that yields a total gain of 34.3 mV/V.

### Temperature sensor

The EPC9173 board is equipped with a temperature sensor (U40 – AD590) that is centrally located on the bottom of the board that reports an analog voltage reading proportional to the measured temperature using the following equation :

$$T = \left( \frac{V \cdot 1000}{7.87} \right) - 273.15 \text{ [}^\circ\text{C]}$$

### Connection and controller mate options

A 40 pin connector is used to interface power, PWM signals and analog feedback signals between the interface control board and the EPC9173 motor drive inverter. Table 2 gives the map (J60) for each signal.

### LED indicators

The EPC9173 has a number of LED indicators indicating the presence of the various supply voltages as follows:

- 5 V LED (**orange**) – indicates the 5 V supply is operational
- 3.3 V LED (**yellow**) – indicates the 3.3 V supply is operational

**Table 2: Controller interface connection (J60) pin assignment map**

Pin #	Pin name		Pin #
2	PWMH1	GND	1
4	PWML1	GND	3
6	PWMH2	GND	5
8	PWML2	GND	7
10	PWMH3	3V3 <sup>(1)</sup>	9
12	PWML3	3V3 <sup>(1)</sup>	11
14	EncA	3V3 <sup>(1)</sup>	13
Index Slot			
18	EncB	AGND	17
20	EncI	AGND	19
22	Vdc	AGND	21
24	Vsns1	AGND	23
26	Vsns2	AGND	25
28	Vsns3	AGND	27
30	N.C.	AGND	29
32	Isns1	AGND	31
34	Isns2	AGND	33
36	Isns3	AGND	35
38	EN/Pgood	OC_FLT/ <sup>(2)</sup>	37
40	Tsns	LEDact	39

<sup>(1)</sup> 3.3 V is connected through the resistor R803 (installed by default)

<sup>(2)</sup> OC\_FLT/ is connected through the resistor R60 (installed by default)

**Test Points**

A number of test-points are available for easy measurement of various nodes as follows:

- Touch-point pad for the 5 V supply
- Touch-point pad for the 3.3 V supply
- Touch-point pad for the Over-current detect
- A SMD hookup for each phase voltage
- A Touch-point for each amplified current signal (after jumper choice)
- Touch-point pad for the shaft encoder A or Hall\_A signal
- Touch-point pad for the shaft encoder B or Hall\_B signal
- Touch-point pad for the shaft encoder Index or Hall\_C signal

All analog signals are measured with respect to analog ground (AGND) using a Touch/point pad. All digital signals are measured with respect to digital ground (GND) using a SMD hookup. All the test point locations are shown in figure 3.

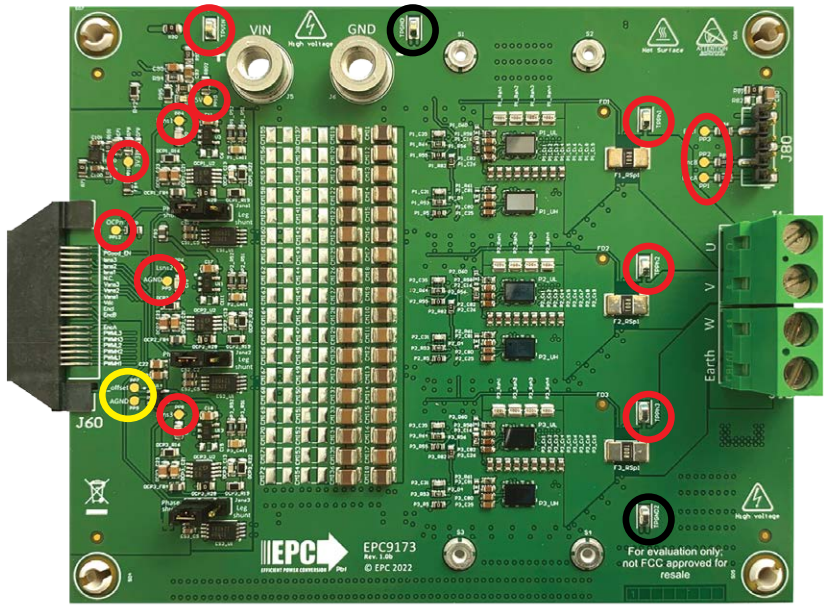

Figure 3: EPC9173 test point pad and hookup locations and designations. In black the PGND reference points and in yellow the AGND reference point.

**Over-current protection**

The EPC9173 includes an overcurrent detect circuit that triggers if any of the three phases current measurement exceeds 50 A. Once an overcurrent is triggered, the active low OC signal will remain low for a short period of time, determined by the RC time constant of R12 and C9 (3.6 μs). The OC detect signal can be passed on to the controller as OC\_FLT through R60 (installed by default). The OC signal should not be loaded by the controller and a high input impedance circuit must be used to read the status. Loading the OC signal will affect the reset time or could place the inverter in permanent over-current state.

**Jumper Settings**

The EPC9173 is provided with jumpers with functions given in table 3.

**Table 3: Jumper settings function**

Jumper	Installed	Open
Jnsx	Position 1-2 leg shunt current sensing analog signal selected Position 2-3 in phase current sensing analog signal selected (Pin 3 of Jnsx is near control connector)	Not allowed. The jumpers Jsns1, Jsns2 and Jsns3 must be installed in any of the two possible positions.

Any combination of valid position settings may be selected.

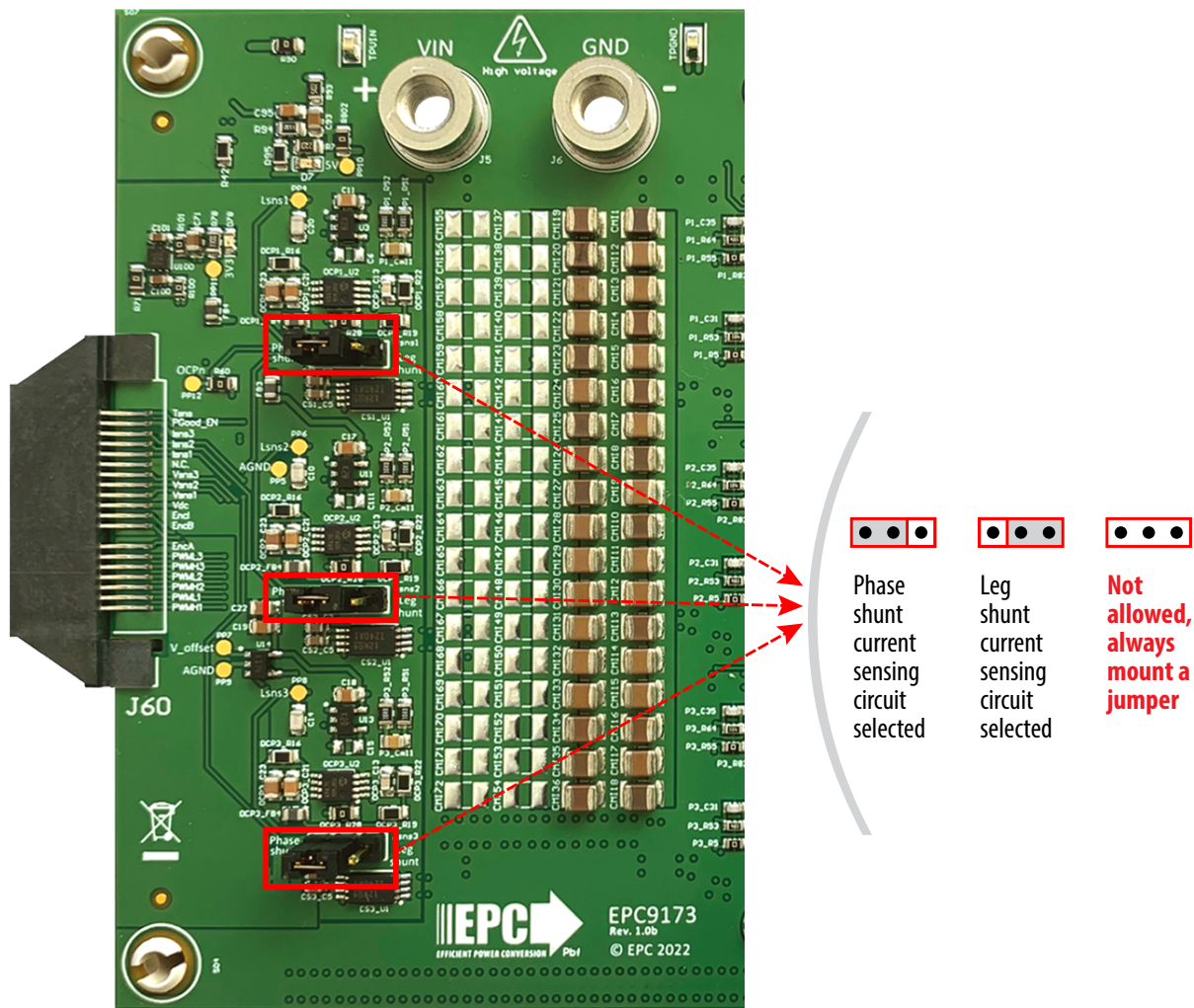

Figure 4: Over-current and current sensing circuits jumper settings

**Shaft Encoder / Hall effect sensors**

Connector (J80) is used to connect a shaft sensor to the EPC9173 motor drive inverter that is compatible with optical quadrature encoders or hall effect sensors and provides supply voltage for the encoder. The available voltage selections can be made by installing the applicable resistors as follows: 5 V using R81 (default), and 3.3 V using R82. The filtered signals are then provided to the controller connector (J60).

**Compatible Controllers**

A list of compatible controllers for the EPC9173 is given in table 4 for both Motor drive and DC-DC applications.

**Table 4: Compatible controller interface and controller boards to the EPC9173**

Controller Board Number	Controller Manufacturer	Controller	Target Application
EPC9147A - Rev. 2.1	Microchip - MA330031-2	dsPIC33EP256MC506	Motor Drive
EPC9147B <sup>1</sup> - Rev. 1.0	Texas Instruments - LAUNCHXL-F28379D	TMS320F2837xD	Motor Drive
EPC9147C - Rev. 1.0	ST Microelectronics	NUCLEO-G431RB	Motor Drive
EPC9147E - Rev. 2.0	Generic Interface board	N/A	Motor Drive or DC-DC converter
EPC9528 - Rev. 3.0	Generic controller board	dsPIC33CK256MP503	DC-DC converter

<sup>1</sup>Available soon

## APPLICATION CONFIGURATION

### Motor Drive Inverter

A 3-phase BLDC motor drive inverter is the primary application case for which the EPC9173 board was designed for and can be used for either sensor-less or shaft encoder sensor configurations. The motor drive controller options are given in table 4 giving the user various mainstream choices that leverage existing resources to simplify and speed up development and evaluation. Figure 5 shows the simplicity of connecting a controller and motor to the EPC9173. **In the default configuration, the EPC9173 is paired with the EPC9147C that is preprogrammed to power and control a NEMA 34 size motor from Teknic M-3411P-LN-08D, with DC supply voltage of 48 V using sensor-less field orientated control with space vector pulse width modulation (SVPWM).**

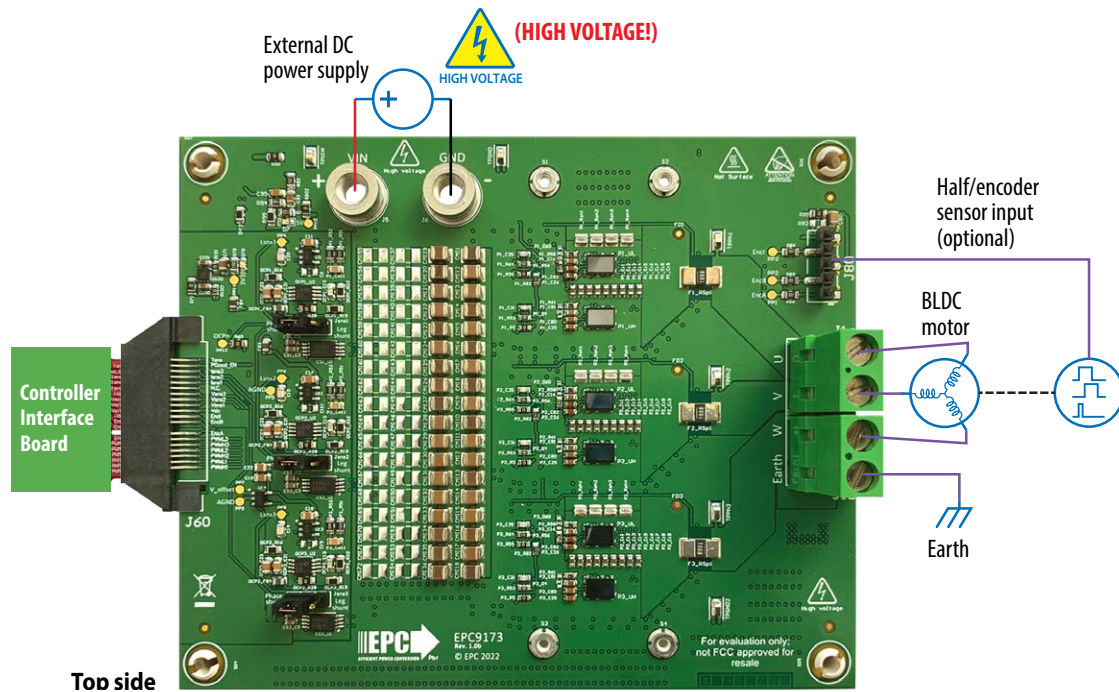

Figure 5: Connection diagram of the EPC9173 configured as a motor drive inverter

## QUICK START PROCEDURE

For this quick start procedure only the **motor drive application** using the EPC9147C controller is presented.

Follow the procedure below to operate the specific motor Teknic M-3411P-LN-08D with EPC9173 and controller board:

1. Mate the EPC9173 with an applicable controller interface board as given in table 4. Review the QSG of corresponding control interface board for detailed operating procedures. For this procedure, the EPC9147C is used.
2. Connect the correct motor, whose parameters are programmed into the controller, to the EPC9173 at connector J1 and the DC power supply at connectors J5 and J6 (**Observe correct polarity, there is no inverse polarity protection on board**) and shown in figure 5.
3. Preset the main supply voltage to the operating voltage and turn on and observe the power LEDs illuminate. Press the Start/Stop button to start the motor spinning. Additional controls are available using ST Microelectronics motor control software. Please review the [EPC9147C QSG](#) for details.
4. Once operational, make the necessary measurements.
5. For shutdown, press the Start/Stop button to stop the motor spinning, then turn off the main DC power supply.

### THERMAL CONSIDERATIONS

The EPC9173 is intended for bench evaluation at room ambient temperatures and under either natural convection or forced air cooling. The addition of a heatsink can significantly improve the heat dissipation from the eGaN ICs and increase the current capacity of these devices, while ensuring to not exceed the absolute maximum die temperature of 125°C.

The EPC9173 board is equipped with four mechanical spacers (S1, S2, S3, S4) that can be used to easily attach a standard quarter-brick converter heatsink as shown in figures 6 and 7, and only requires a thermal interface material (TIM), a heatsink, and screws.

The heatsink is held in place using screws that fasten to the mechanical spacers which will accept 6 mm long M2 x 0.4 mm thread screws such as McMasterCarr 95836A109.

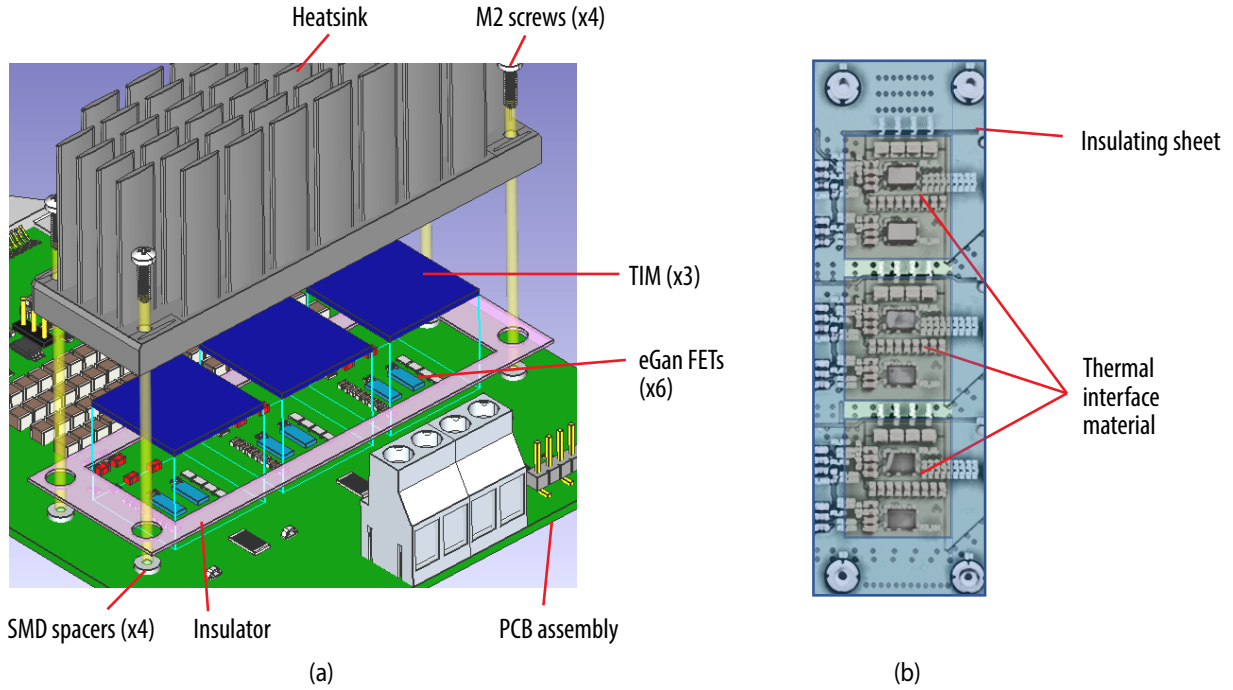

Figure 6: Details for attaching a heatsink to the board. (a) exploded 3D perspective, (b) top view showing the insulator sheet details with opening for the TIM with location of the eGaN FETs

When assembling the heatsink, it is necessary add a thin insulating layer to prevent the heat-spreader from short circuiting with components that have exposed conductors such as capacitors and resistors, as shown in figure 8 and 9. Note that the heatsink is ground connected. A rectangular opening in the insulator must be provided to allow the TIM to be placed over the FETs to be cooled with a minimum clearance of 3 mm on each side of the rectangle encompassing the FETs. The TIM will then be similar in size or slightly smaller than the opening in the insulator shown by the red dashed outline in figure 7. The insulator sheet material is made by Laird P/N A14692-30 Tgard K52 with thickness of 0.051 mm (0.0020”).

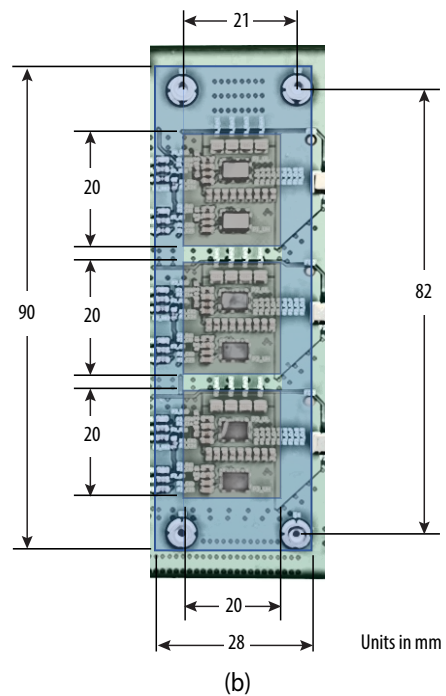

Figure 7: (a) minimum TIM coverage area (b) Insulator sheet details



A TIM is added to improve the interface thermal conductance between the GaN ICs and the attached heatsink. The choice of TIM needs to consider the following characteristics:

- **Mechanical compliance** – During the attachment of the heat spreader, the TIM underneath is compressed from its original thickness to the vertical gap distance between the spacers and the ICs. This volume compression exerts a force on the ICs. A maximum compression of 2:1 is recommended for maximum thermal performance and to constrain the mechanical force which maximizes thermal mechanical reliability.
- **Electrical insulation** – The backside of the eGaN ICs is a silicon substrate that is connected to power ground.. To prevent short-circuiting the power ground to the earth ground if the heat sink is connected to the earth ground, so, the TIM must be of high dielectric strength to provide adequate electrical insulation in addition to its thermal properties.
- **Thermal performance** – The choice of thermal interface material will affect the thermal performance of the thermal solution. Higher thermal conductivity materials is preferred to provide higher thermal conductance at the interface.

EPC recommends the following thermal interface materials:

- **t-Global** P/N: TG-A1780 x 0.5 mm (highest conductivity of 17.8 W/m-K)
- **t-Global** P/N: TG-A6200 x 0.5 mm (moderate conductivity of 6.2 W/m-K)
- **Bergquist** P/N: GP5000-0.02 (~0.5 mm with conductivity of 5 W/m-K)
- **Bergquist** P/N: GPTGP7000ULM-0.020 (conductivity of 7 W/m-K)

The default TIM used for the EPC9173 is made by t-Global Technology, measures 20 x 20 x 0.5 mm thick with P/N TG-A1780-20-20-0.5. The natural convection cooling heatsink used for the EPC9173 is Alpha Novatech, Inc., model # LPD2790-35BM-3V6.

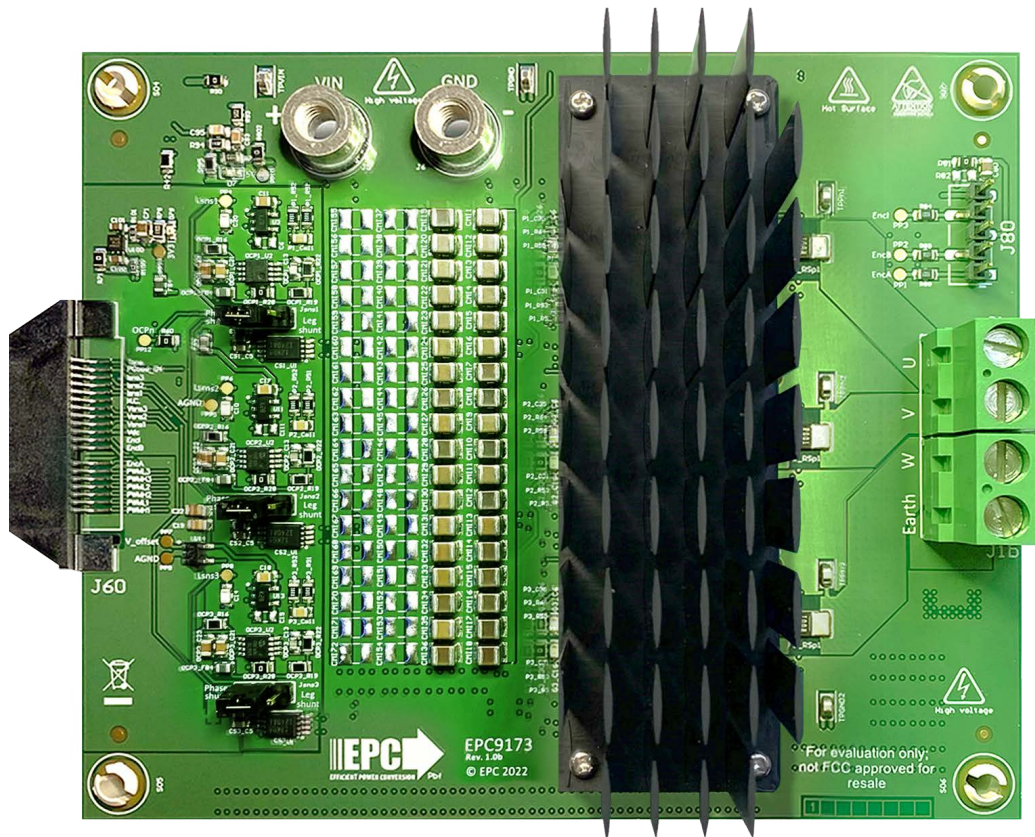

Figure 8: Natural convection cooling heatsink installed on the EPC9173 inverter board

### EXPERIMENTAL VALIDATION EXAMPLE

The EPC9173 motor drive inverter, paired with the EPC9147C interface controller, was operated from a 48 V<sub>DC</sub> supply voltage while switching at 100 kHz, 50 ns dead-time setting, powering a 500 W motor with a sinusoidal modulation frequency of 5 Hz and delivering to the motor a phase current of 25 A<sub>RMS</sub> without heat sink and under natural convection and 35 A<sub>RMS</sub> with heat sink and natural convection.

### MEASURED PHASE LEG WAVEFORMS

The measured waveforms of the motor phase current and phase voltages while the EPC9173 is delivering 33 A<sub>RMS</sub> into each motor phase at 48 V<sub>DC</sub> Bus is shown in figure 9.

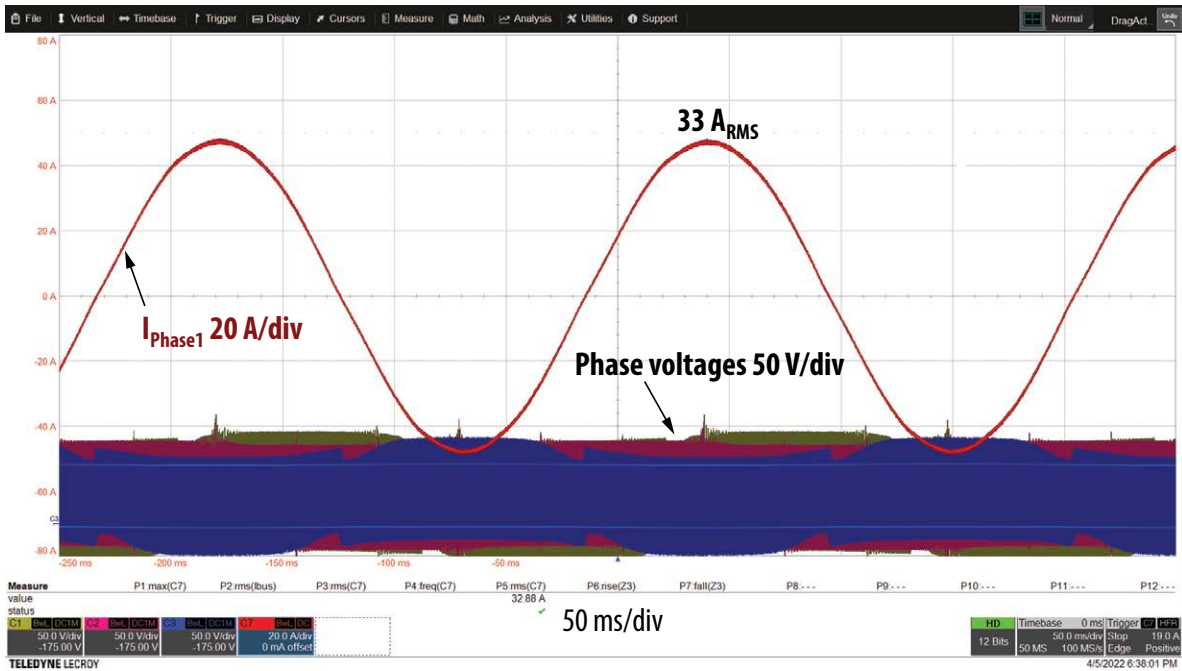

Figure 9: Phase 1 current and phase 1, 2 and 3 voltages versus DcBus-

### THERMAL PERFORMANCE

The thermal performance summary of the EPC9173 board is depicted in figure 10. When operated on a motor bench at ambient temperature of 25 °C, with 48 V<sub>DC</sub> supply and natural convection, the EPC9173 can deliver 20 A<sub>RMS</sub> per phase without a heatsink and 25 A<sub>RMS</sub> per phase with a heatsink attached with a temperature rise below 50°C from eGaN IC case to ambient. The temperature was recorded at steady state. The EPC9173 can withstand short transients (less than 30 s) up to 35 A<sub>RMS</sub>.

Motor drive operating points at PWM = 20, 50, and 100 kHz, deadtime = 50 ns, with and without heatsink at 25.5°C ambient temperature. Under natural convection.

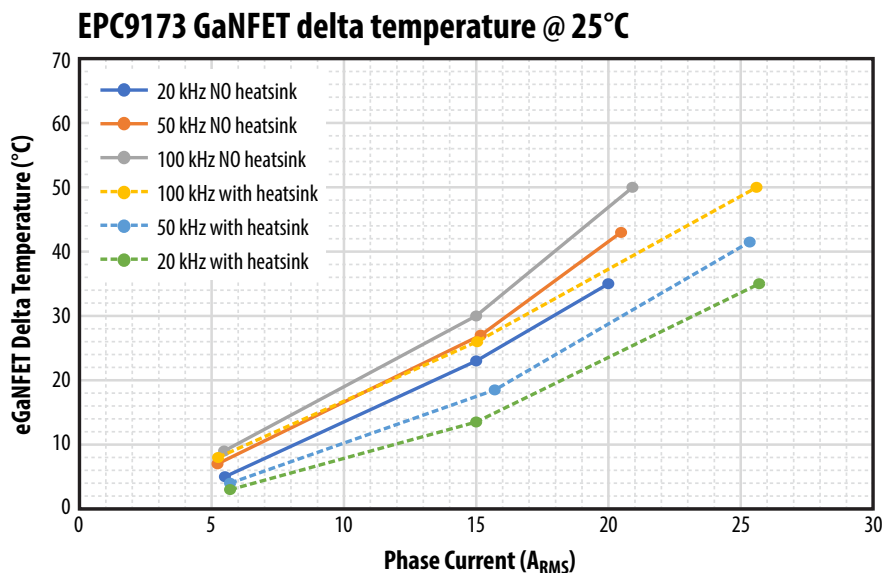

Figure 10: EPC9173 GaN IC temperature (\*) increase vs. the ambient temperature [25°C]. Measurements taken at various PWM frequencies.

(\*) With heatsink, junction temperature has not measured directly. The indicated delta temperature with heat sink is the hottest point at the base of the heat sink.

The graph in Figure 11 shows the correlation between the measured temperature by the on-board temperature sensor placed beneath the phase-2 eGaN ICs on the bottom side of the PCB and the infra-red camera die case temperature for same eGaN IC that is measured without a heatsink and with only natural convection cooling. Figure 12 shows the location of the temperature sensor used to measure the bottom side of the PCB temperature.

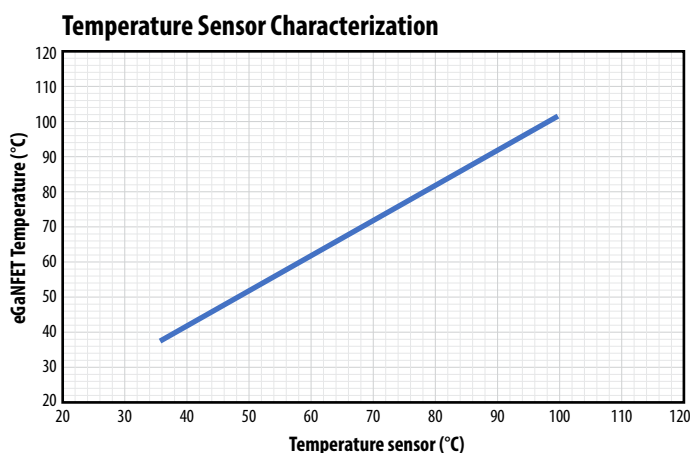

Figure 11: eGaN IC case temperature vs. temperature sensor placed on bottom of the PCB. Operation under natural convection without heatsink.

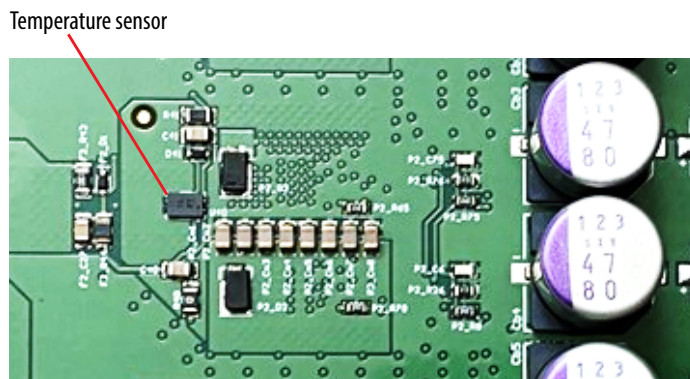

Figure 12: Temperature sensor location on the bottom side of the PCB

For support files including schematic, Bill of Materials (BOM), and gerber files please visit the EPC9173 landing page at: <https://epc-co.com/epc/products/evaluation-boards/epc9173>

## For More Information:

Please contact [info@epc-co.com](mailto:info@epc-co.com)  
or your local sales representative

Visit our website:  
[www.epc-co.com](http://www.epc-co.com)

Sign-up to receive  
EPC updates at  
[bit.ly/EPCupdates](http://bit.ly/EPCupdates)  
or text "EPC" to 22828



**DigiKey**

EPC Products are distributed through Digi-Key.

[www.digikey.com](http://www.digikey.com)

### Demonstration Board Notification

**The EPC9173 and EPC9173 boards are intended for product evaluation purposes only. They are not intended for commercial use nor are they FCC approved for resale.** Replace components on the Evaluation Board only with those parts shown on the parts list (or Bill of Materials) in the Quick Start Guide. Contact an authorized EPC representative with any questions. This board is intended to be used by certified professionals, in a lab environment, following proper safety procedures. Use at your own risk.

As an evaluation tool, this board is not designed for compliance with the European Union directive on electromagnetic compatibility or any other such directives or regulations. As board builds are at times subject to product availability, it is possible that boards may contain components or assembly materials that are not RoHS compliant. Efficient Power Conversion Corporation (EPC) makes no guarantee that the purchased board is 100% RoHS compliant.

The Evaluation board (or kit) is for demonstration purposes only and neither the Board nor this Quick Start Guide constitute a sales contract or create any kind of warranty, whether express or implied, as to the applications or products involved.

Disclaimer: EPC reserves the right at any time, without notice, to make changes to any products described herein to improve reliability, function, or design. EPC does not assume any liability arising out of the application or use of any product or circuit described herein; neither does it convey any license under its patent rights, or other intellectual property whatsoever, nor the rights of others.