

Figure 11: EPC90120 schematic

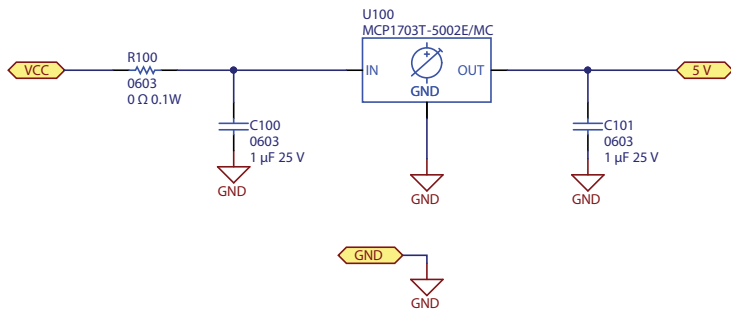

Figure 12: 5 V Regulator

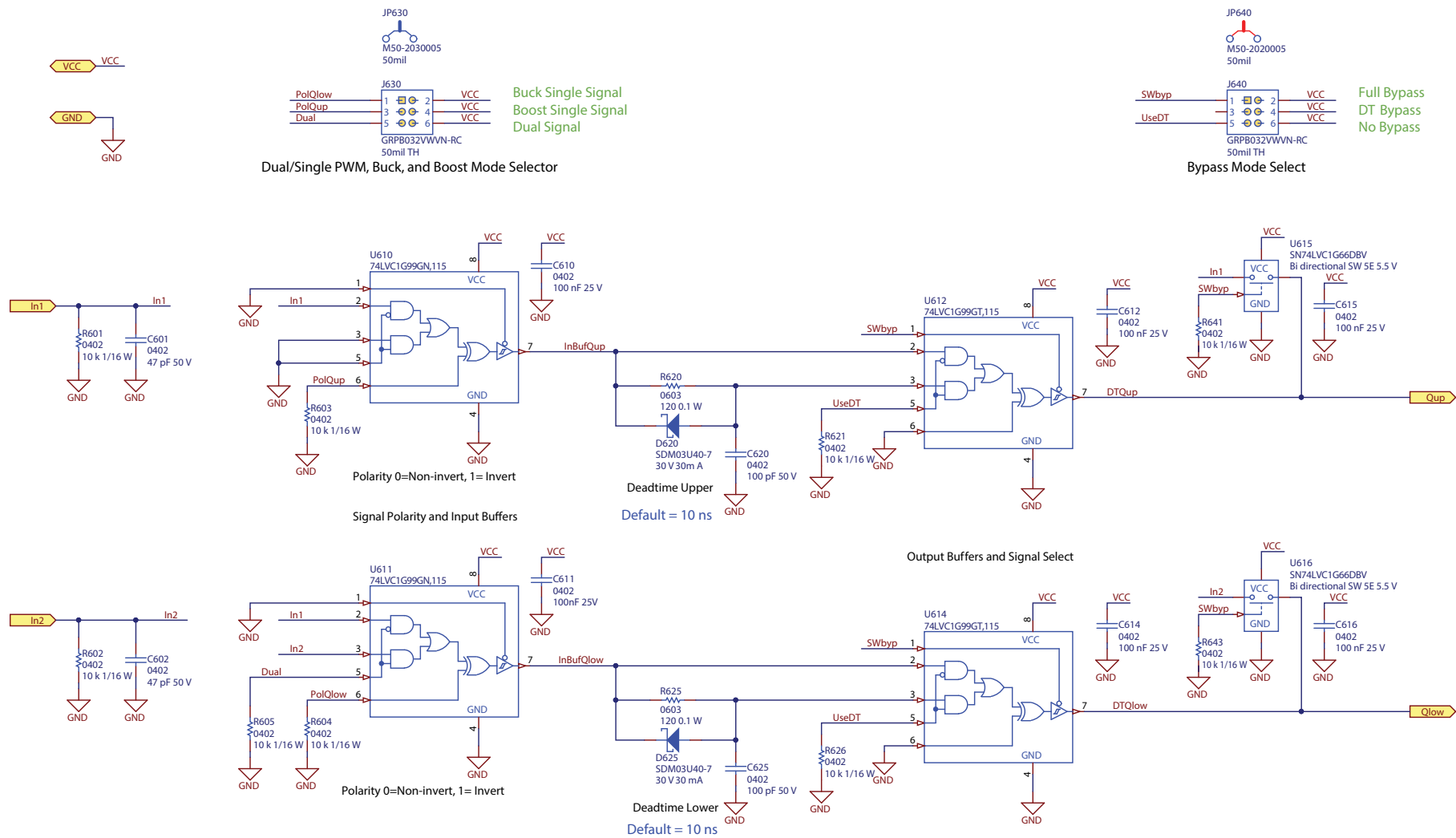

Figure 13: Dead-time and bypass circuit

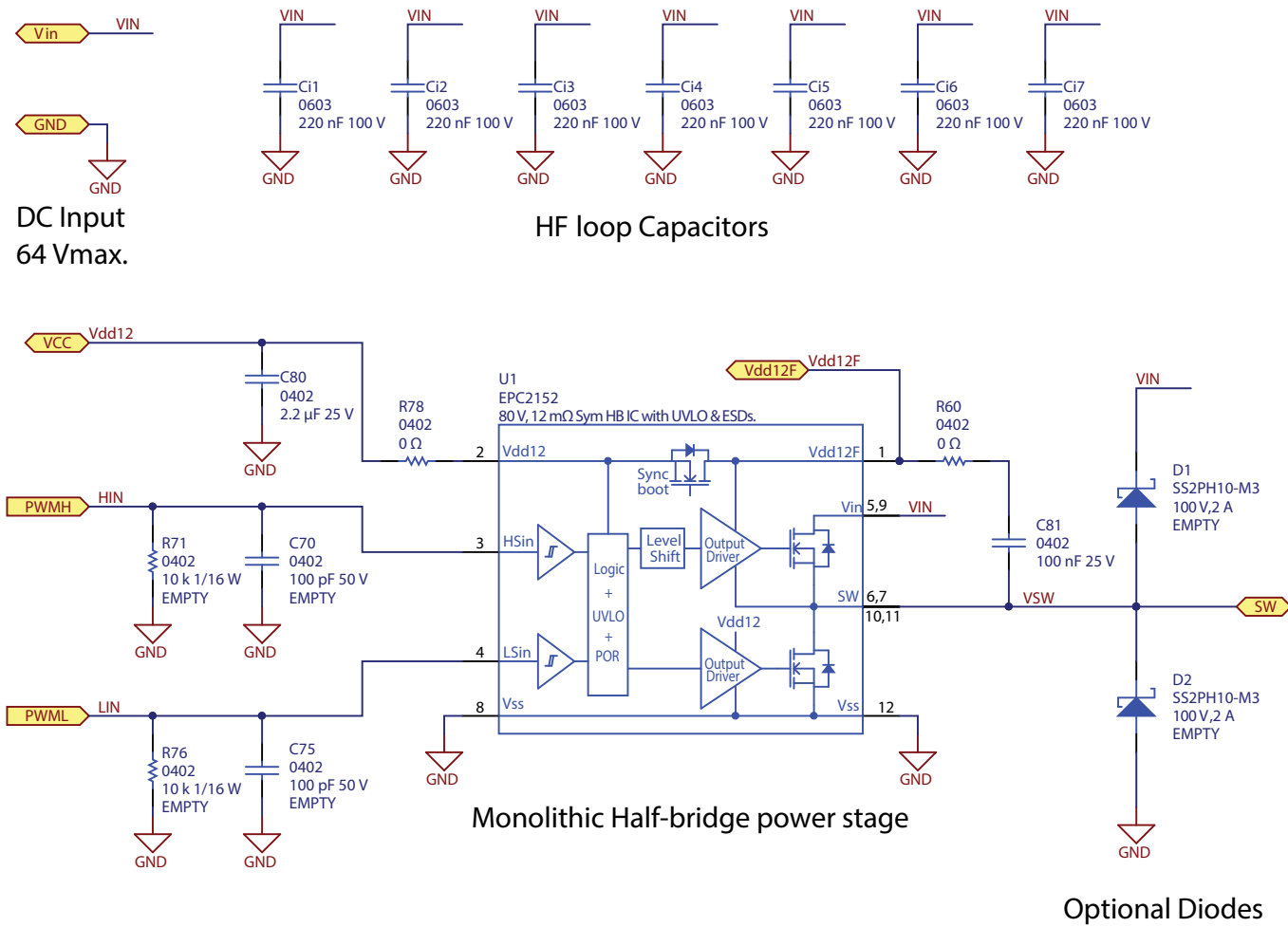

Figure 14: EPC2152 power stage circuit