

Figure 13: EPC90141 main schematic

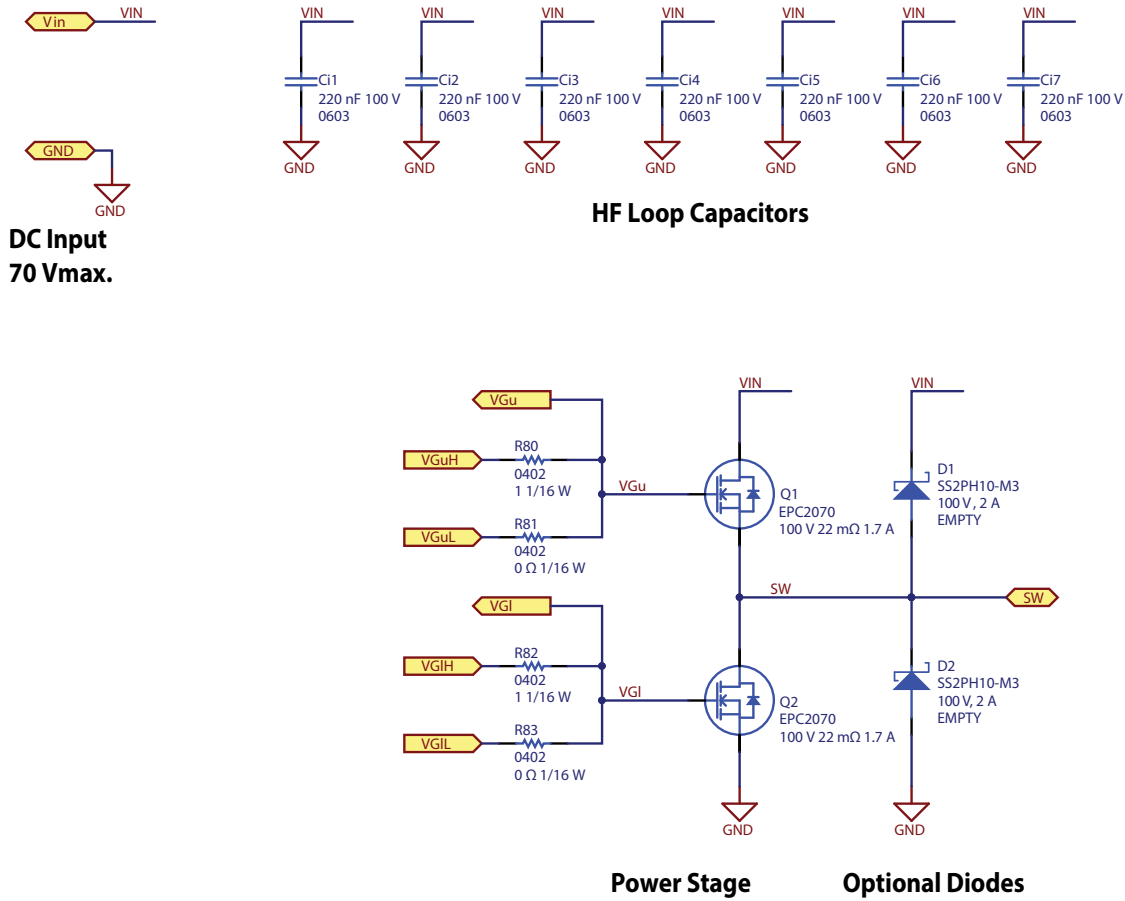

Figure 14: Power Stage schematic using the EPC2070

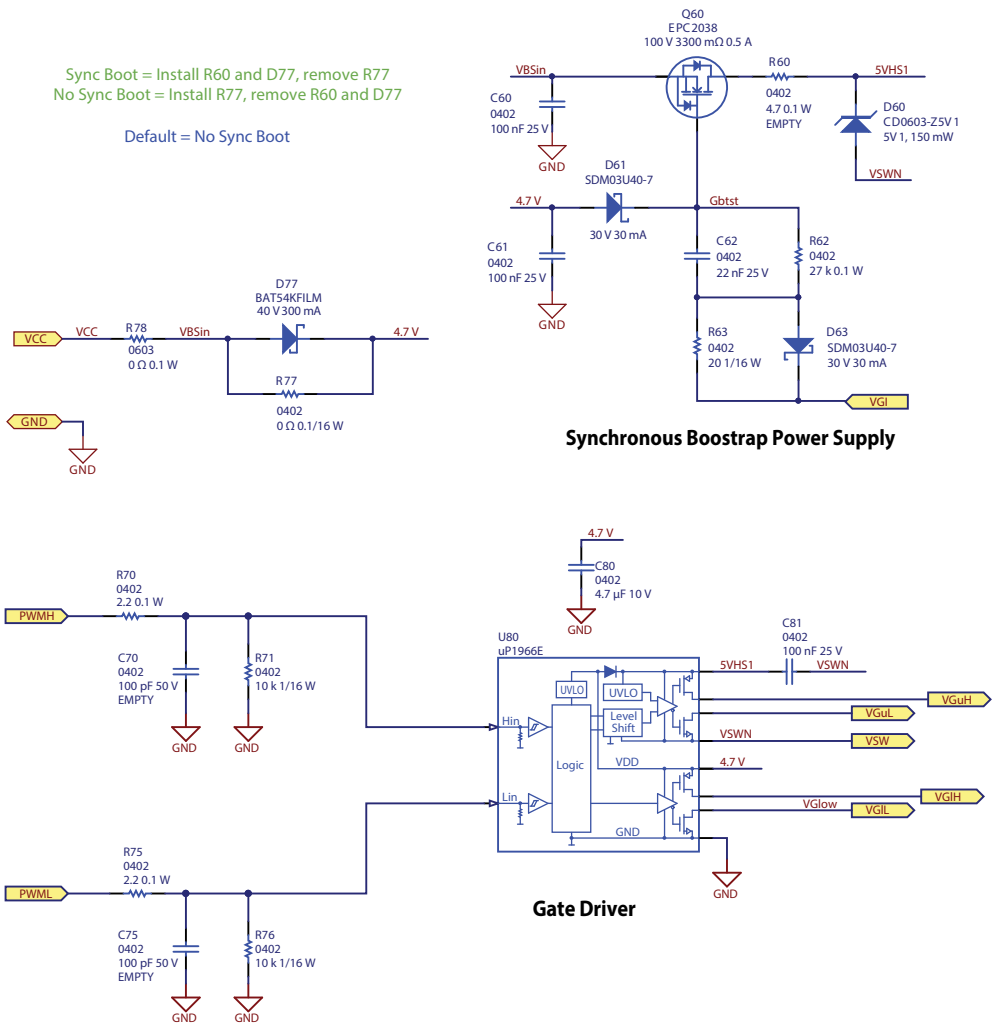

Figure 15: Gate Driver schematic

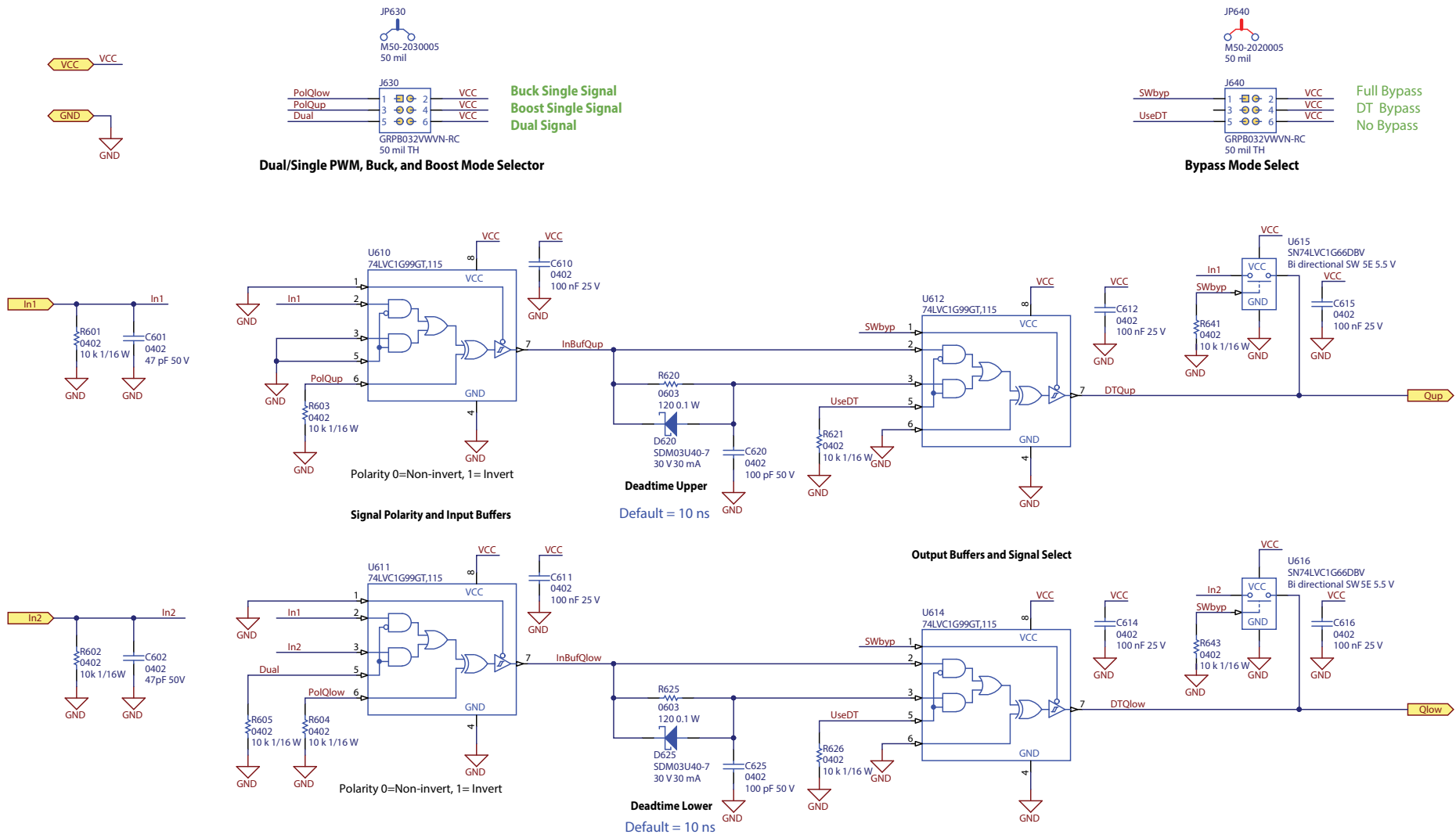

Figure 16: Dead-time and Bypass schematic

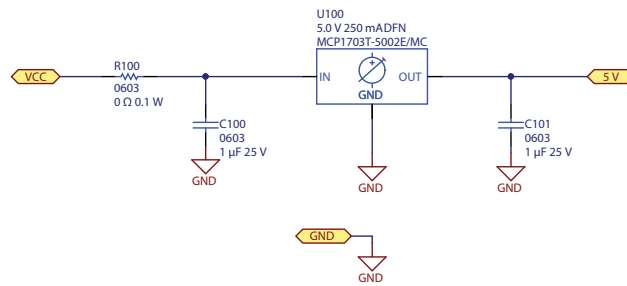

Figure 17: Logic Supply Regulator schematic